



---

10 GEORGE STREET, SUITE 208, LOWELL, MA 01852 • 978-201-9390 • WWW.LANDPLEX.COM  
CONSULTING • SURVEYING • CIVIL ENGINEERING • GEO-TECHNICAL

## STORMWATER REPORT

8, 10, 12, & 18 COLBY FARM LANE

NEWBURYPORT, MASSACHUSETTS

FEBRUARY 14, 2020

(REVISED – APRIL 13, 2020)

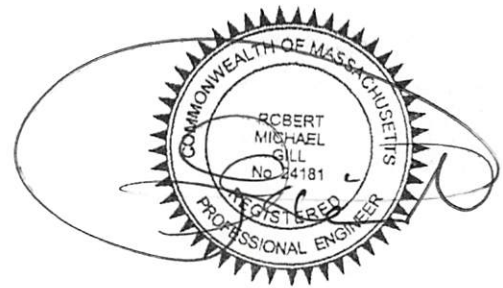

PREPARED FOR:

THE DALY GROUP  
225 STEDMAN STREET  
LOWELL, MASSACHUSETTS

## **TABLE OF CONTENTS:**

<b>SECTION 1.0</b>	<b>PROJECT NARRATIVE WITH SUMMARY TABLE AND MASSDEP STORMWATER STANDARDS</b> <ul style="list-style-type: none"><li>1.1 PROJECT NARRATIVE</li><li>1.2 MASSDEP STORMWATER STANDARDS</li><li>1.3 STORMWATER CHECKLIST</li></ul>
<b>SECTION 2.0</b>	<b>MAPS</b> <ul style="list-style-type: none"><li>2.1 LOCUS MAP</li><li>2.2 USGS TOPOGRAPHIC MAP</li><li>2.3 NEWBURYPORT GIS MAP</li><li>2.4 AERIAL IMAGE</li><li>2.5 WEB SOILS SURVEY SOILS MAP</li><li>2.6 FEMA FIRMETTE FLOOD PLAIN MAP</li></ul>
<b>SECTION 3.0</b>	<b>STORMWATER CALCULATIONS AND DATA</b> <ul style="list-style-type: none"><li>3.1 DRAINAGE CALCULATIONS (HYDROCAD DATA) WITH ATTACHED SUBCATCHMENT PLANS</li></ul>
<b>SECTION 4.0</b>	<b>CONSTRUCTION-PERIOD, OPERATION &amp; MAINTENANCE, AND LONG-TERM POLLUTION PREVENTION PLAN</b> <ul style="list-style-type: none"><li>4.1 INTRODUCTION</li><li>4.2 RESPONSIBLE PARTIES</li><li>4.3 CONSTRUCTION PERIOD MAINTENANCE PROCEDURES</li><li>4.4 POST-DEVELOPMENT PERIOD MAINTENANCE PROCEDURES</li></ul>
<b>SECTION 5.0</b>	<b>ATTACHMENTS</b> <ul style="list-style-type: none"><li>- STORMTECH SC-310 CHAMBER TECHNICAL SPECIFICATIONS AND CONSTRUCTION INFORMATION</li><li>- SOIL LOGS</li></ul>

# **SECTION 1: PROJECT NARRATIVE WITH SUMMARY TABLE AND MASSDEP STORMWATER STANDARDS**

## **SECTION 1.1 - PROJECT NARRATIVE**

The subject property, located at 8, 10, 12, & 18 Colby Farm Lane, is located in the R2 Residential District in the City of Newburyport, Massachusetts. The subject property contains 7.631± acres of area and has 655.68 feet of frontage along the northerly side of Colby Farm Lane. Presently the property is used for commercial vehicle storage and commercial construction materials storage within the primary contiguous upland area..

The on-site soils are identified by the USDA Natural Resource Conservation Service Web Soil Survey as Charlton-Rock outcrop-Hollis complex with a Hydrologic Soil Group (HSG) rating of "A". Multiple soil test holes have been conducted across the site, confirming the presence of sandy soils with HSG "A" rating. Bedrock ledge and seasonal high water tables were also encountered in the soil test holes. The subject property gradually slopes from east to west down to the central bordering vegetated wetland (BVW).

The owner is proposing to raze the existing building and remove the existing paved and crushed gravel parking area, and to construct an Open Space Residential Subdivision (OSRD) residential development with six (6) single-family dwellings and one (1) duplex, for a total of eight (8) proposed residential units. The OSRD development will include a proposed playground in a central open space area, an emergency vehicle turn-around area, and large areas of restoration within the 25-foot "no-disturb" buffer to the BVW which currently contain either crushed gravel or paved parking areas. Stormwater runoff will be treated and infiltrated in compliance with the MassDEP Stormwater Standards, specifically with a deep-sump catch basin and trench drain, sediment and oil separators, and sub-surface infiltration systems comprised of Stormtech SC-310 infiltration chambers.

**SECTION 1.2 - MASSDEP STORMWATER STANDARDS**

**STANDARD 1** - No new stormwater conveyances (e.g. outfalls) may discharge untreated stormwater directly to or cause erosion in wetlands or waters of the Commonwealth.

All new impervious areas are treated on site.

This Standard is met.

**STANDARD 2** - Stormwater management systems shall be designed so that post-development peak discharge rates do not exceed pre-development peak discharge rates.

The following table summarizes the Pre- vs. Post-development runoff calculations from the attached HydroCAD data, demonstrating compliance with Standard 2:

	Analysis Point	1R Wetlands
<b>2-YEAR (3.1 inches)</b>	<b>Pre Runoff (cfs)</b>	0.18
	<b>Post Runoff (cfs)</b>	0.00
	<b>Change</b>	-0.18 (-100.0%)
<b>10-YEAR (4.7 inches)</b>	<b>Pre Runoff (cfs)</b>	1.11
	<b>Post Runoff (cfs)</b>	0.69
	<b>Change</b>	-0.42 (-37.8%)
<b>25-YEAR (5.8 inches)</b>	<b>Pre Runoff (cfs)</b>	2.03
	<b>Post Runoff (cfs)</b>	1.67
	<b>Change</b>	-0.36 (-17.7%)
<b>100-YEAR (8.3 inches)</b>	<b>Pre Runoff (cfs)</b>	4.55 [0.389af]
	<b>Post Runoff (cfs)</b>	4.46 [0.206af]
	<b>Change</b>	-0.09 (-2.0%)

This Standard is met.

**STANDARD 3** - Loss of annual recharge to groundwater shall be eliminated or minimized through the use of infiltration measures including environmentally sensitive site design, low impact development techniques, stormwater best management practices, and good operation and maintenance. At a minimum, the annual recharge from the post-development site shall approximate the annual recharge from pre-development conditions based on soil type. This Standard is met when the stormwater management system is designed to infiltrate the required recharge volume as determined in accordance with the Massachusetts Stormwater Handbook.

**Required Recharge Volume (R<sub>v</sub>)**

$R_v = \text{Total Post-Dev. Impervious Area (sf)} * 0.60 \text{ inches for A-type soils} * 1/12 \text{ ft/inches}$

$R_v = 25,155 \pm \text{sf} * 0.60 \text{ inches} * 1/12 \text{ ft/inches}$

$R_v = 1,258 \pm \text{cf}$

The proposed infiltration trench and subsurface infiltration systems have a total volume of 2,342±cf, which exceeds the Required Recharge Volume.

**Drawdown Time**

Pond 11P (SIS1) has a storage volume of 618±cf, and a bottom area of 530±sf:

$T \{11P\} = \text{Volume} / (K * \text{Bottom Area})$

$= (618 \pm \text{cf}) / (8.27 \text{ in/hr} * (1 \text{ foot}/12 \text{ inches}) * 530 \pm \text{sf})$

$= 1.7 \text{ Hours}$

$1.7 \text{ Hours} < 72 \text{ Hours}$

Pond 12P (SIS2) has a storage volume of 1,584±cf, and a bottom area of 1,273±sf:

$T \{12P\} = \text{Volume} / (K * \text{Bottom Area})$

$= (1,584 \pm \text{cf}) / (8.27 \text{ in/hr} * (1 \text{ foot}/12 \text{ inches}) * 1,273 \pm \text{sf})$

$= 1.8 \text{ Hours}$

$1.8 \text{ Hours} < 72 \text{ Hours}$

Pond 13P (Infiltration Trench) has a storage volume of 140±cf, and a bottom area of 70±sf:

$T \{13P\} = \text{Volume} / (K * \text{Bottom Area})$

$= (140 \pm \text{cf}) / (8.27 \text{ in/hr} * (1 \text{ foot}/12 \text{ inches}) * 70 \pm \text{sf})$

$= 2.9 \text{ Hours}$

$2.9 \text{ Hours} < 72 \text{ Hours}$

This Standard is met.

**STANDARD 4** - Stormwater management systems shall be designed to remove 80% of the average annual post-construction load of Total Suspended Solids (TSS). This Standard is met when: (a) Suitable practices for source control and pollution prevention are identified in a long-term pollution prevention plan, and thereafter are implemented and maintained; (b) Structural stormwater best management practices are sized to capture the required water quality volume determined in accordance with the Massachusetts Stormwater Handbook; and (c) Pretreatment is provided in accordance with the Massachusetts Stormwater Handbook.

There is one (1) treatment trains for the proposed development:  
 (1.) Catch Basin – Sediment and Oil Separator – Sub-surface Infiltration System

For Treatment Train (1.):

<u>Initial Load</u>	<u>BMP</u>	<u>TSS Removal</u>	<u>Remaining TSS Load</u>
1.00	Catch Basin (25%)	-0.25	0.75
0.75	Sediment and Oil Separator (25%)	-0.19	0.56
0.56	Sub-surface Infil. System (80%)	-0.45	0.11

The treatment train removes 89% of the TSS Load.

**Water Quality Volume**

$$\begin{aligned}
 V_{WQ} &= (D_{WQ} / 12 \text{ inches/foot}) * (A_{IMP}) \\
 &= (1.0 \text{ inch} / 12 \text{ inches/foot}) * (25,155 \pm sf) \\
 &= 2,096cf
 \end{aligned}$$

The proposed infiltration trench and subsurface infiltration systems have a total volume of 2,342±cf, which exceeds the Required Recharge Volume.

This Standard is met.

**STANDARD 5** - Land Uses with Higher Potential Pollutant Loads (LUHPPL).

The proposed development is not a LUHPPL.

This Standard is met.

**STANDARD 6** - Stormwater discharges within critical areas.

The proposed development is not located within a critical area.

This Standard is met.

**STANDARD 7** - Redevelopment Projects.

The proposed development is a redevelopment project, though it is fully compliant with the MassDEP Stormwater Management Standards.

This Standard is met.

**STANDARD 8** - *A plan to control construction-related impacts including erosion, sedimentation, and other pollutant sources during construction and land disturbance activities (construction period erosion, sedimentation, and pollution prevention plan) shall be developed and implemented.*

Please refer to the *Construction, Operation and Maintenance, and Long-term Pollution Prevention Plan*.

This Standard is met.

**STANDARD 9** - *A long-term operation and maintenance plan shall be developed and implemented to ensure that stormwater management systems function as designed.*

Please refer to the *Construction, Operation and Maintenance, and Long-term Pollution Prevention Plan*.

This Standard is met.

**STANDARD 10** - *All illicit discharges to the stormwater management system are prohibited.*

Please refer to the *Construction, Operation and Maintenance, and Long-term Pollution Prevention Plan*.

This Standard is met.





# Checklist for Stormwater Report

## A. Introduction

**Important:** When filling out forms on the computer, use only the tab key to move your cursor - do not use the return key.

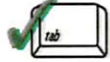

A Stormwater Report must be submitted with the Notice of Intent permit application to document compliance with the Stormwater Management Standards. The following checklist is NOT a substitute for the Stormwater Report (which should provide more substantive and detailed information) but is offered here as a tool to help the applicant organize their Stormwater Management documentation for their Report and for the reviewer to assess this information in a consistent format. As noted in the Checklist, the Stormwater Report must contain the engineering computations and supporting information set forth in Volume 3 of the [Massachusetts Stormwater Handbook](#). The Stormwater Report must be prepared and certified by a Registered Professional Engineer (RPE) licensed in the Commonwealth.

The Stormwater Report must include:

- The Stormwater Checklist completed and stamped by a Registered Professional Engineer (see page 2) that certifies that the Stormwater Report contains all required submittals.<sup>1</sup> This Checklist is to be used as the cover for the completed Stormwater Report.
- Applicant/Project Name
- Project Address
- Name of Firm and Registered Professional Engineer that prepared the Report
- Long-Term Pollution Prevention Plan required by Standards 4-6
- Construction Period Pollution Prevention and Erosion and Sedimentation Control Plan required by Standard 8<sup>2</sup>
- Operation and Maintenance Plan required by Standard 9

In addition to all plans and supporting information, the Stormwater Report must include a brief narrative describing stormwater management practices, including environmentally sensitive site design and LID techniques, along with a diagram depicting runoff through the proposed BMP treatment train. Plans are required to show existing and proposed conditions, identify all wetland resource areas, NRCS soil types, critical areas, Land Uses with Higher Potential Pollutant Loads (LUHPPL), and any areas on the site where infiltration rate is greater than 2.4 inches per hour. The Plans shall identify the drainage areas for both existing and proposed conditions at a scale that enables verification of supporting calculations.

As noted in the Checklist, the Stormwater Management Report shall document compliance with each of the Stormwater Management Standards as provided in the Massachusetts Stormwater Handbook. The soils evaluation and calculations shall be done using the methodologies set forth in Volume 3 of the Massachusetts Stormwater Handbook.

To ensure that the Stormwater Report is complete, applicants are required to fill in the Stormwater Report Checklist by checking the box to indicate that the specified information has been included in the Stormwater Report. If any of the information specified in the checklist has not been submitted, the applicant must provide an explanation. The completed Stormwater Report Checklist and Certification must be submitted with the Stormwater Report.

<sup>1</sup> The Stormwater Report may also include the Illicit Discharge Compliance Statement required by Standard 10. If not included in the Stormwater Report, the Illicit Discharge Compliance Statement must be submitted prior to the discharge of stormwater runoff to the post-construction best management practices.

<sup>2</sup> For some complex projects, it may not be possible to include the Construction Period Erosion and Sedimentation Control Plan in the Stormwater Report. In that event, the issuing authority has the discretion to issue an Order of Conditions that approves the project and includes a condition requiring the proponent to submit the Construction Period Erosion and Sedimentation Control Plan before commencing any land disturbance activity on the site.



# Checklist for Stormwater Report

## B. Stormwater Checklist and Certification

The following checklist is intended to serve as a guide for applicants as to the elements that ordinarily need to be addressed in a complete Stormwater Report. The checklist is also intended to provide conservation commissions and other reviewing authorities with a summary of the components necessary for a comprehensive Stormwater Report that addresses the ten Stormwater Standards.

*Note:* Because stormwater requirements vary from project to project, it is possible that a complete Stormwater Report may not include information on some of the subjects specified in the Checklist. If it is determined that a specific item does not apply to the project under review, please note that the item is not applicable (N.A.) and provide the reasons for that determination.

A complete checklist must include the Certification set forth below signed by the Registered Professional Engineer who prepared the Stormwater Report.

### Registered Professional Engineer's Certification

I have reviewed the Stormwater Report, including the soil evaluation, computations, Long-term Pollution Prevention Plan, the Construction Period Erosion and Sedimentation Control Plan (if included), the Long-term Post-Construction Operation and Maintenance Plan, the Illicit Discharge Compliance Statement (if included) and the plans showing the stormwater management system, and have determined that they have been prepared in accordance with the requirements of the Stormwater Management Standards as further elaborated by the Massachusetts Stormwater Handbook. I have also determined that the information presented in the Stormwater Checklist is accurate and that the information presented in the Stormwater Report accurately reflects conditions at the site as of the date of this permit application.

Registered Professional Engineer Block and Signature

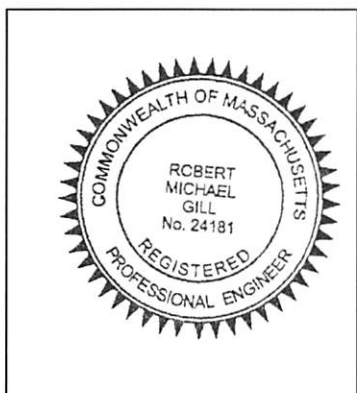

*[Handwritten Signature]* 4-17-2020  
Signature and Date

## Checklist

**Project Type:** Is the application for new development, redevelopment, or a mix of new and redevelopment?

- New development
- Redevelopment
- Mix of New Development and Redevelopment



# Checklist for Stormwater Report

---

## Checklist (continued)

**LID Measures:** Stormwater Standards require LID measures to be considered. Document what environmentally sensitive design and LID Techniques were considered during the planning and design of the project:

- No disturbance to any Wetland Resource Areas
- Site Design Practices (e.g. clustered development, reduced frontage setbacks)
- Reduced Impervious Area (Redevelopment Only)
- Minimizing disturbance to existing trees and shrubs
- LID Site Design Credit Requested:
  - Credit 1
  - Credit 2
  - Credit 3
- Use of "country drainage" versus curb and gutter conveyance and pipe
- Bioretention Cells (includes Rain Gardens)
- Constructed Stormwater Wetlands (includes Gravel Wetlands designs)
- Treebox Filter
- Water Quality Swale
- Grass Channel
- Green Roof
- Other (describe): \_\_\_\_\_

### Standard 1: No New Untreated Discharges

- No new untreated discharges
- Outlets have been designed so there is no erosion or scour to wetlands and waters of the Commonwealth
- Supporting calculations specified in Volume 3 of the Massachusetts Stormwater Handbook included.



# Checklist for Stormwater Report

---

## Checklist (continued)

### Standard 2: Peak Rate Attenuation

- Standard 2 waiver requested because the project is located in land subject to coastal storm flowage and stormwater discharge is to a wetland subject to coastal flooding.
- Evaluation provided to determine whether off-site flooding increases during the 100-year 24-hour storm.
- Calculations provided to show that post-development peak discharge rates do not exceed pre-development rates for the 2-year and 10-year 24-hour storms. If evaluation shows that off-site flooding increases during the 100-year 24-hour storm, calculations are also provided to show that post-development peak discharge rates do not exceed pre-development rates for the 100-year 24-hour storm.

### Standard 3: Recharge

- Soil Analysis provided.
- Required Recharge Volume calculation provided.
- Required Recharge volume reduced through use of the LID site Design Credits.
- Sizing the infiltration, BMPs is based on the following method: Check the method used.
  - Static
  - Simple Dynamic
  - Dynamic Field<sup>1</sup>
- Runoff from all impervious areas at the site discharging to the infiltration BMP.
- Runoff from all impervious areas at the site is *not* discharging to the infiltration BMP and calculations are provided showing that the drainage area contributing runoff to the infiltration BMPs is sufficient to generate the required recharge volume.
- Recharge BMPs have been sized to infiltrate the Required Recharge Volume.
- Recharge BMPs have been sized to infiltrate the Required Recharge Volume *only* to the maximum extent practicable for the following reason:
  - Site is comprised solely of C and D soils and/or bedrock at the land surface
  - M.G.L. c. 21E sites pursuant to 310 CMR 40.0000
  - Solid Waste Landfill pursuant to 310 CMR 19.000
  - Project is otherwise subject to Stormwater Management Standards only to the maximum extent practicable.
- Calculations showing that the infiltration BMPs will drain in 72 hours are provided.
- Property includes a M.G.L. c. 21E site or a solid waste landfill and a mounding analysis is included.

---

<sup>1</sup> 80% TSS removal is required prior to discharge to infiltration BMP if Dynamic Field method is used.



# Checklist for Stormwater Report

---

## Checklist (continued)

### Standard 3: Recharge (continued)

- The infiltration BMP is used to attenuate peak flows during storms greater than or equal to the 10-year 24-hour storm and separation to seasonal high groundwater is less than 4 feet and a mounding analysis is provided.
- Documentation is provided showing that infiltration BMPs do not adversely impact nearby wetland resource areas.

### Standard 4: Water Quality

The Long-Term Pollution Prevention Plan typically includes the following:

- Good housekeeping practices;
  - Provisions for storing materials and waste products inside or under cover;
  - Vehicle washing controls;
  - Requirements for routine inspections and maintenance of stormwater BMPs;
  - Spill prevention and response plans;
  - Provisions for maintenance of lawns, gardens, and other landscaped areas;
  - Requirements for storage and use of fertilizers, herbicides, and pesticides;
  - Pet waste management provisions;
  - Provisions for operation and management of septic systems;
  - Provisions for solid waste management;
  - Snow disposal and plowing plans relative to Wetland Resource Areas;
  - Winter Road Salt and/or Sand Use and Storage restrictions;
  - Street sweeping schedules;
  - Provisions for prevention of illicit discharges to the stormwater management system;
  - Documentation that Stormwater BMPs are designed to provide for shutdown and containment in the event of a spill or discharges to or near critical areas or from LUHPPL;
  - Training for staff or personnel involved with implementing Long-Term Pollution Prevention Plan;
  - List of Emergency contacts for implementing Long-Term Pollution Prevention Plan.
- A Long-Term Pollution Prevention Plan is attached to Stormwater Report and is included as an attachment to the Wetlands Notice of Intent.
  - Treatment BMPs subject to the 44% TSS removal pretreatment requirement and the one inch rule for calculating the water quality volume are included, and discharge:
    - is within the Zone II or Interim Wellhead Protection Area
    - is near or to other critical areas
    - is within soils with a rapid infiltration rate (greater than 2.4 inches per hour)
    - involves runoff from land uses with higher potential pollutant loads.
  - The Required Water Quality Volume is reduced through use of the LID site Design Credits.
  - Calculations documenting that the treatment train meets the 80% TSS removal requirement and, if applicable, the 44% TSS removal pretreatment requirement, are provided.



# Checklist for Stormwater Report

---

## Checklist (continued)

### Standard 4: Water Quality (continued)

- The BMP is sized (and calculations provided) based on:
  - The ½" or 1" Water Quality Volume or
  - The equivalent flow rate associated with the Water Quality Volume and documentation is provided showing that the BMP treats the required water quality volume.
- The applicant proposes to use proprietary BMPs, and documentation supporting use of proprietary BMP and proposed TSS removal rate is provided. This documentation may be in the form of the propriety BMP checklist found in Volume 2, Chapter 4 of the Massachusetts Stormwater Handbook and submitting copies of the TARP Report, STEP Report, and/or other third party studies verifying performance of the proprietary BMPs.
- A TMDL exists that indicates a need to reduce pollutants other than TSS and documentation showing that the BMPs selected are consistent with the TMDL is provided.

### Standard 5: Land Uses With Higher Potential Pollutant Loads (LUHPPLs)

- The NPDES Multi-Sector General Permit covers the land use and the Stormwater Pollution Prevention Plan (SWPPP) has been included with the Stormwater Report.
- The NPDES Multi-Sector General Permit covers the land use and the SWPPP will be submitted **prior to** the discharge of stormwater to the post-construction stormwater BMPs.
- The NPDES Multi-Sector General Permit does **not** cover the land use.
- LUHPPLs are located at the site and industry specific source control and pollution prevention measures have been proposed to reduce or eliminate the exposure of LUHPPLs to rain, snow, snow melt and runoff, and been included in the long term Pollution Prevention Plan.
- All exposure has been eliminated.
- All exposure has **not** been eliminated and all BMPs selected are on MassDEP LUHPPL list.
- The LUHPPL has the potential to generate runoff with moderate to higher concentrations of oil and grease (e.g. all parking lots with >1000 vehicle trips per day) and the treatment train includes an oil grit separator, a filtering bioretention area, a sand filter or equivalent.

### Standard 6: Critical Areas

- The discharge is near or to a critical area and the treatment train includes only BMPs that MassDEP has approved for stormwater discharges to or near that particular class of critical area.
- Critical areas and BMPs are identified in the Stormwater Report.



# Checklist for Stormwater Report

## Checklist (continued)

### Standard 7: Redevelopments and Other Projects Subject to the Standards only to the maximum extent practicable

- The project is subject to the Stormwater Management Standards only to the maximum Extent Practicable as a:
  - Limited Project
  - Small Residential Projects: 5-9 single family houses or 5-9 units in a multi-family development provided there is no discharge that may potentially affect a critical area.
  - Small Residential Projects: 2-4 single family houses or 2-4 units in a multi-family development with a discharge to a critical area
  - Marina and/or boatyard provided the hull painting, service and maintenance areas are protected from exposure to rain, snow, snow melt and runoff
  - Bike Path and/or Foot Path
  - Redevelopment Project
  - Redevelopment portion of mix of new and redevelopment.
- Certain standards are not fully met (Standard No. 1, 8, 9, and 10 must always be fully met) and an explanation of why these standards are not met is contained in the Stormwater Report.
- The project involves redevelopment and a description of all measures that have been taken to improve existing conditions is provided in the Stormwater Report. The redevelopment checklist found in Volume 2 Chapter 3 of the Massachusetts Stormwater Handbook may be used to document that the proposed stormwater management system (a) complies with Standards 2, 3 and the pretreatment and structural BMP requirements of Standards 4-6 to the maximum extent practicable and (b) improves existing conditions.

### Standard 8: Construction Period Pollution Prevention and Erosion and Sedimentation Control

A Construction Period Pollution Prevention and Erosion and Sedimentation Control Plan must include the following information:

- Narrative;
  - Construction Period Operation and Maintenance Plan;
  - Names of Persons or Entity Responsible for Plan Compliance;
  - Construction Period Pollution Prevention Measures;
  - Erosion and Sedimentation Control Plan Drawings;
  - Detail drawings and specifications for erosion control BMPs, including sizing calculations;
  - Vegetation Planning;
  - Site Development Plan;
  - Construction Sequencing Plan;
  - Sequencing of Erosion and Sedimentation Controls;
  - Operation and Maintenance of Erosion and Sedimentation Controls;
  - Inspection Schedule;
  - Maintenance Schedule;
  - Inspection and Maintenance Log Form.
- A Construction Period Pollution Prevention and Erosion and Sedimentation Control Plan containing the information set forth above has been included in the Stormwater Report.



# Checklist for Stormwater Report

## Checklist (continued)

### Standard 8: Construction Period Pollution Prevention and Erosion and Sedimentation Control (continued)

- The project is highly complex and information is included in the Stormwater Report that explains why it is not possible to submit the Construction Period Pollution Prevention and Erosion and Sedimentation Control Plan with the application. A Construction Period Pollution Prevention and Erosion and Sedimentation Control has **not** been included in the Stormwater Report but will be submitted **before** land disturbance begins.
- The project is **not** covered by a NPDES Construction General Permit.
- The project is covered by a NPDES Construction General Permit and a copy of the SWPPP is in the Stormwater Report.
- The project is covered by a NPDES Construction General Permit but no SWPPP been submitted. The SWPPP will be submitted BEFORE land disturbance begins.

### Standard 9: Operation and Maintenance Plan

- The Post Construction Operation and Maintenance Plan is included in the Stormwater Report and includes the following information:
  - Name of the stormwater management system owners;
  - Party responsible for operation and maintenance;
  - Schedule for implementation of routine and non-routine maintenance tasks;
  - Plan showing the location of all stormwater BMPs maintenance access areas;
  - Description and delineation of public safety features;
  - Estimated operation and maintenance budget; and
  - Operation and Maintenance Log Form.
- The responsible party is **not** the owner of the parcel where the BMP is located and the Stormwater Report includes the following submissions:
  - A copy of the legal instrument (deed, homeowner's association, utility trust or other legal entity) that establishes the terms of and legal responsibility for the operation and maintenance of the project site stormwater BMPs;
  - A plan and easement deed that allows site access for the legal entity to operate and maintain BMP functions.

### Standard 10: Prohibition of Illicit Discharges

- The Long-Term Pollution Prevention Plan includes measures to prevent illicit discharges;
- An Illicit Discharge Compliance Statement is attached;
- NO Illicit Discharge Compliance Statement is attached but will be submitted **prior to** the discharge of any stormwater to post-construction BMPs.



## **SECTION 2: MAPS**

**FIGURE 2.1**  
**LOCUS MAP**  
**(NOT TO SCALE)**



8, 10, 12, & 18 Colby Farm Lane

**FIGURE 2.2**  
**USGS TOPOGRAPHIC MAP**  
**(NO SCALE)**

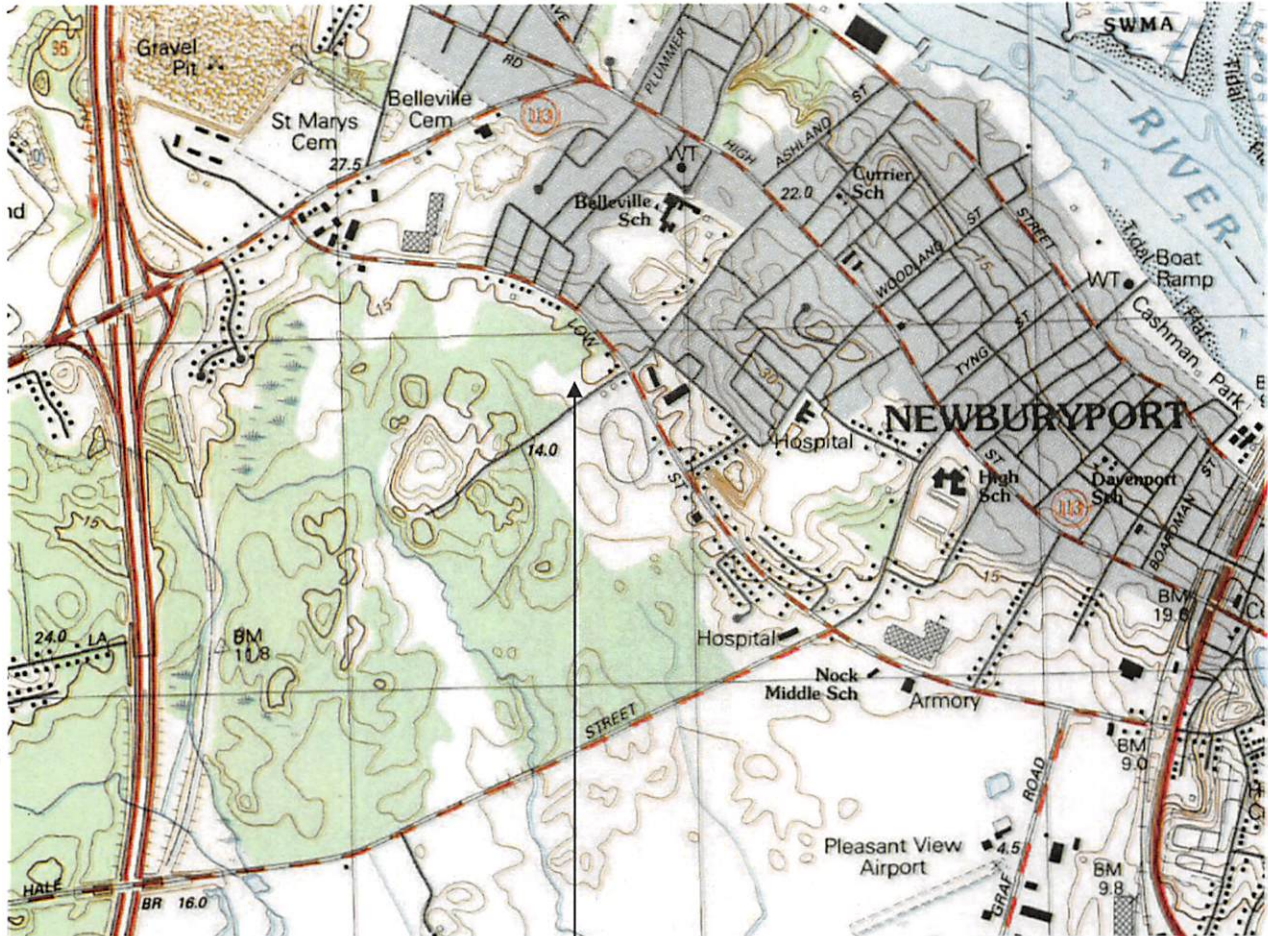

8, 10, 12, & 18 Colby Farm Lane

**FIGURE 2.3**  
**NEWBURYPORT GIS MAP**  
**(NO SCALE)**

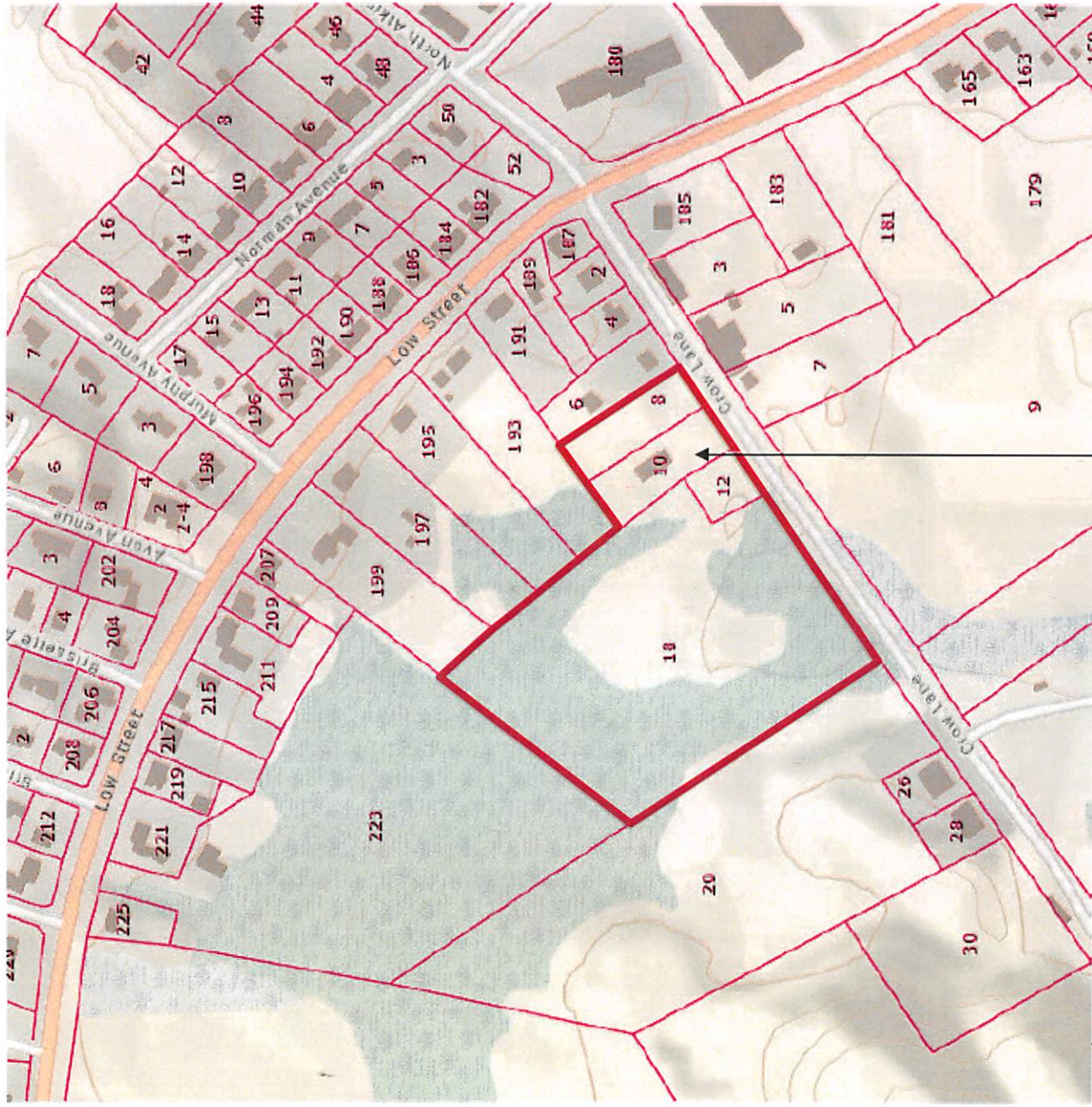

8, 10, 12, & 18 Colby Farm Lane

**FIGURE 2.4**  
**AERIAL IMAGE**  
**(NO SCALE)**



**FIGURE 2.5**  
**WEB SOILS SURVEY MAP**  
**(NOT TO SCALE)**



8, 10, 12, & 18 Colby Farm Lane

Map unit symbol	Map unit name	Rating	Acres in ADOI	Percent of ADOI
12A	Waybriol silt loam, 0 to 3 percent slopes	C/D	0.1	3.0%
16A	Scanto silt loam, 0 to 3 percent slopes	C/D	0.3	9.0%
51A	Swamesee muck, 0 to 1 percent slopes	B/D	0.3	1.4%
711B	Chanton-Rock outcrop-hills complex, 3 to 8 percent slopes	A	1.5	60.6%
Totals for Area of Interest			2.4	100.0%

FIGURE 2.6  
FEMA FIRMETTE FLOOD PLAIN MAP  
(NO SCALE)

# National Flood Hazard Layer FIRMette

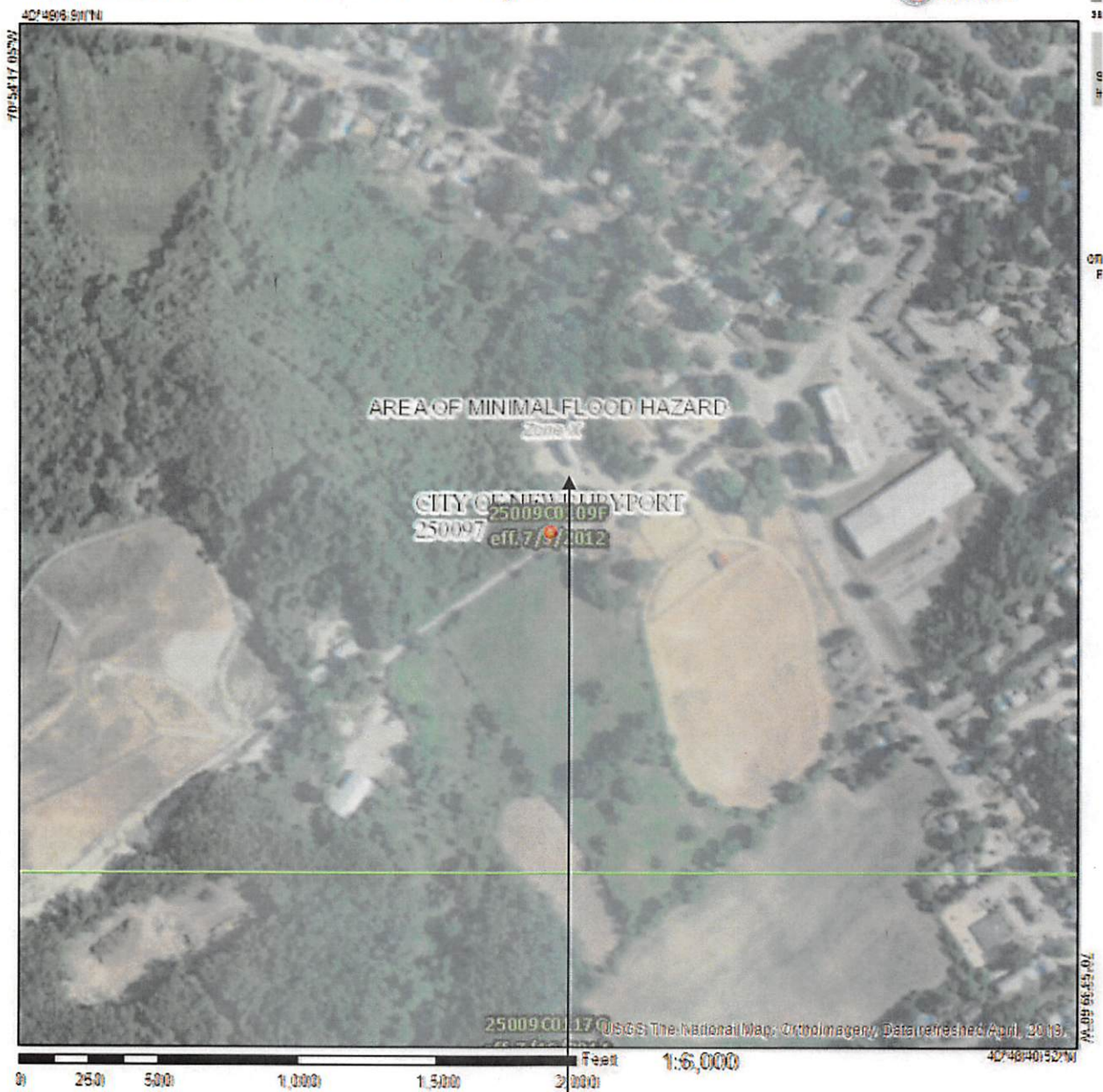

8, 10, 12, & 18 Colby Farm Lane

## **SECTION 3: STORMWATER CALCULATIONS AND DATA**



PER PLAN 262 OF 1975

SCALE: 1"=40'  
0 20 40

<b>PRE-DEVELOPMENT SUBCATCHMENT PLAN</b>
<b>8, 10, 12, &amp; 18 COLBY FARM LANE NEWBURYPORT MASSACHUSETTS</b>
<b>APRIL 13, 2020</b>
PLAN PREPARED FOR: <b>THE DALY GROUP 225 STEDMAN STREET LOWELL, MA 01851</b>
PLAN PREPARED BY: <b>LANDPLEX</b> CIVIL ENGINEERING - SURVEYING 10 GEORGE STREET, UNIT 208 LOWELL, MASSACHUSETTS 01852 978-201-9390 - LANDPLEX.COM

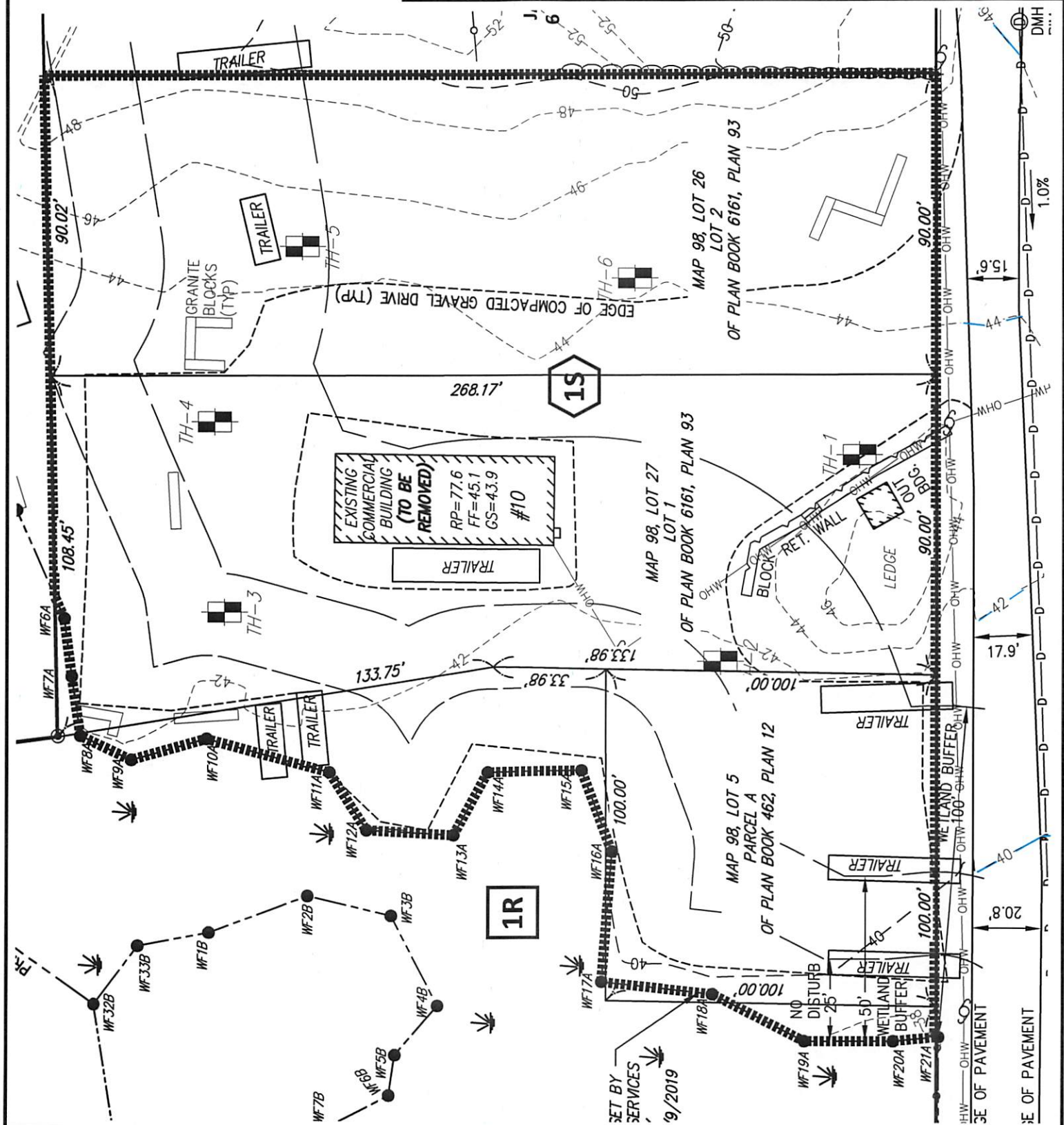

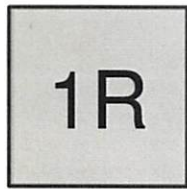

Wetlands



Pre-development Area

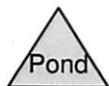

**HydroCAD-8Colby-PRE**

Type III 24-hr 2-Year Rainfall=3.10"

Prepared by {enter your company name here}

Page 2

HydroCAD® 7.10 s/n 003867 © 2005 HydroCAD Software Solutions LLC

2/14/2020

**Subcatchment 1S: Pre-development Area**

Runoff = 0.18 cfs @ 12.37 hrs, Volume= 0.033 af, Depth&gt; 0.28"

Runoff by SCS TR-20 method, UH=SCS, Time Span= 0.00-24.00 hrs, dt= 0.05 hrs  
Type III 24-hr 2-Year Rainfall=3.10"

Area (sf)	CN	Description
28,830	32	Woods/grass comb., Good, HSG A
32,630	76	Gravel roads, HSG A
1,880	98	Paved parking & roofs
63,340	57	Weighted Average

Tc (min)	Length (feet)	Slope (ft/ft)	Velocity (ft/sec)	Capacity (cfs)	Description
7.1	45	0.0672	0.1		<b>Sheet Flow, Sheet</b> Woods: Light underbrush n= 0.400 P2= 3.10"
1.2	5	0.0678	0.1		<b>Sheet Flow, Sheet</b> Woods: Light underbrush n= 0.400 P2= 3.10"
0.3	25	0.0678	1.3		<b>Shallow Concentrated Flow, Shallow woods</b> Woodland Kv= 5.0 fps
0.7	26	0.0151	0.6		<b>Shallow Concentrated Flow, Shallow woods</b> Woodland Kv= 5.0 fps
0.7	100	0.0151	2.5		<b>Shallow Concentrated Flow, Shallow gravel</b> Paved Kv= 20.3 fps
0.5	19	0.0151	0.6		<b>Shallow Concentrated Flow, Shallow Woods</b> Woodland Kv= 5.0 fps
10.5	220	Total			

**Reach 1R: Wetlands**

Inflow Area = 1.454 ac, Inflow Depth &gt; 0.28" for 2-Year event

Inflow = 0.18 cfs @ 12.37 hrs, Volume= 0.033 af

Outflow = 0.18 cfs @ 12.37 hrs, Volume= 0.033 af, Atten= 0%, Lag= 0.0 min

Routing by Dyn-Stor-Ind method, Time Span= 0.00-24.00 hrs, dt= 0.05 hrs

**HydroCAD-8Colby-PRE**

Type III 24-hr 10-Year Rainfall=4.70"

Prepared by {enter your company name here}

Page 3

HydroCAD® 7.10 s/n 003867 © 2005 HydroCAD Software Solutions LLC

2/14/2020

**Subcatchment 1S: Pre-development Area**

Runoff = 1.11 cfs @ 12.17 hrs, Volume= 0.115 af, Depth&gt; 0.95"

Runoff by SCS TR-20 method, UH=SCS, Time Span= 0.00-24.00 hrs, dt= 0.05 hrs  
Type III 24-hr 10-Year Rainfall=4.70"

Area (sf)	CN	Description
28,830	32	Woods/grass comb., Good, HSG A
32,630	76	Gravel roads, HSG A
1,880	98	Paved parking & roofs
63,340	57	Weighted Average

Tc (min)	Length (feet)	Slope (ft/ft)	Velocity (ft/sec)	Capacity (cfs)	Description
7.1	45	0.0672	0.1		<b>Sheet Flow, Sheet</b> Woods: Light underbrush n= 0.400 P2= 3.10"
1.2	5	0.0678	0.1		<b>Sheet Flow, Sheet</b> Woods: Light underbrush n= 0.400 P2= 3.10"
0.3	25	0.0678	1.3		<b>Shallow Concentrated Flow, Shallow woods</b> Woodland Kv= 5.0 fps
0.7	26	0.0151	0.6		<b>Shallow Concentrated Flow, Shallow woods</b> Woodland Kv= 5.0 fps
0.7	100	0.0151	2.5		<b>Shallow Concentrated Flow, Shallow gravel</b> Paved Kv= 20.3 fps
0.5	19	0.0151	0.6		<b>Shallow Concentrated Flow, Shallow Woods</b> Woodland Kv= 5.0 fps
10.5	220	Total			

**Reach 1R: Wetlands**

Inflow Area = 1.454 ac, Inflow Depth &gt; 0.95" for 10-Year event

Inflow = 1.11 cfs @ 12.17 hrs, Volume= 0.115 af

Outflow = 1.11 cfs @ 12.17 hrs, Volume= 0.115 af, Atten= 0%, Lag= 0.0 min

Routing by Dyn-Stor-Ind method, Time Span= 0.00-24.00 hrs, dt= 0.05 hrs

**HydroCAD-8Colby-PRE**

Type III 24-hr 25-year Rainfall=5.80"

Prepared by {enter your company name here}

Page 4

HydroCAD® 7.10 s/n 003867 © 2005 HydroCAD Software Solutions LLC

2/14/2020

**Subcatchment 1S: Pre-development Area**

Runoff = 2.03 cfs @ 12.17 hrs, Volume= 0.188 af, Depth &gt; 1.55"

Runoff by SCS TR-20 method, UH=SCS, Time Span= 0.00-24.00 hrs, dt= 0.05 hrs  
Type III 24-hr 25-year Rainfall=5.80"

Area (sf)	CN	Description
28,830	32	Woods/grass comb., Good, HSG A
32,630	76	Gravel roads, HSG A
1,880	98	Paved parking & roofs
63,340	57	Weighted Average

Tc (min)	Length (feet)	Slope (ft/ft)	Velocity (ft/sec)	Capacity (cfs)	Description
7.1	45	0.0672	0.1		<b>Sheet Flow, Sheet</b> Woods: Light underbrush n= 0.400 P2= 3.10"
1.2	5	0.0678	0.1		<b>Sheet Flow, Sheet</b> Woods: Light underbrush n= 0.400 P2= 3.10"
0.3	25	0.0678	1.3		<b>Shallow Concentrated Flow, Shallow woods</b> Woodland Kv= 5.0 fps
0.7	26	0.0151	0.6		<b>Shallow Concentrated Flow, Shallow woods</b> Woodland Kv= 5.0 fps
0.7	100	0.0151	2.5		<b>Shallow Concentrated Flow, Shallow gravel</b> Paved Kv= 20.3 fps
0.5	19	0.0151	0.6		<b>Shallow Concentrated Flow, Shallow Woods</b> Woodland Kv= 5.0 fps
10.5	220	Total			

**Reach 1R: Wetlands**

Inflow Area = 1.454 ac, Inflow Depth &gt; 1.55" for 25-year event

Inflow = 2.03 cfs @ 12.17 hrs, Volume= 0.188 af

Outflow = 2.03 cfs @ 12.17 hrs, Volume= 0.188 af, Atten= 0%, Lag= 0.0 min

Routing by Dyn-Stor-Ind method, Time Span= 0.00-24.00 hrs, dt= 0.05 hrs

**Subcatchment 1S: Pre-development Area**

Runoff = 4.55 cfs @ 12.16 hrs, Volume= 0.389 af, Depth> 3.21"

Runoff by SCS TR-20 method, UH=SCS, Time Span= 0.00-24.00 hrs, dt= 0.05 hrs  
 Type III 24-hr 100-Year Rainfall=8.30"

Area (sf)	CN	Description
28,830	32	Woods/grass comb., Good, HSG A
32,630	76	Gravel roads, HSG A
1,880	98	Paved parking & roofs
63,340	57	Weighted Average

Tc (min)	Length (feet)	Slope (ft/ft)	Velocity (ft/sec)	Capacity (cfs)	Description
7.1	45	0.0672	0.1		<b>Sheet Flow, Sheet</b> Woods: Light underbrush n= 0.400 P2= 3.10"
1.2	5	0.0678	0.1		<b>Sheet Flow, Sheet</b> Woods: Light underbrush n= 0.400 P2= 3.10"
0.3	25	0.0678	1.3		<b>Shallow Concentrated Flow, Shallow woods</b> Woodland Kv= 5.0 fps
0.7	26	0.0151	0.6		<b>Shallow Concentrated Flow, Shallow woods</b> Woodland Kv= 5.0 fps
0.7	100	0.0151	2.5		<b>Shallow Concentrated Flow, Shallow gravel</b> Paved Kv= 20.3 fps
0.5	19	0.0151	0.6		<b>Shallow Concentrated Flow, Shallow Woods</b> Woodland Kv= 5.0 fps
10.5	220	Total			

**Reach 1R: Wetlands**

Inflow Area = 1.454 ac, Inflow Depth > 3.21" for 100-Year event  
 Inflow = 4.55 cfs @ 12.16 hrs, Volume= 0.389 af  
 Outflow = 4.55 cfs @ 12.16 hrs, Volume= 0.389 af, Atten= 0%, Lag= 0.0 min

Routing by Dyn-Stor-Ind method, Time Span= 0.00-24.00 hrs, dt= 0.05 hrs

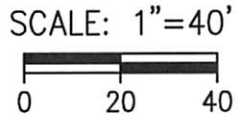
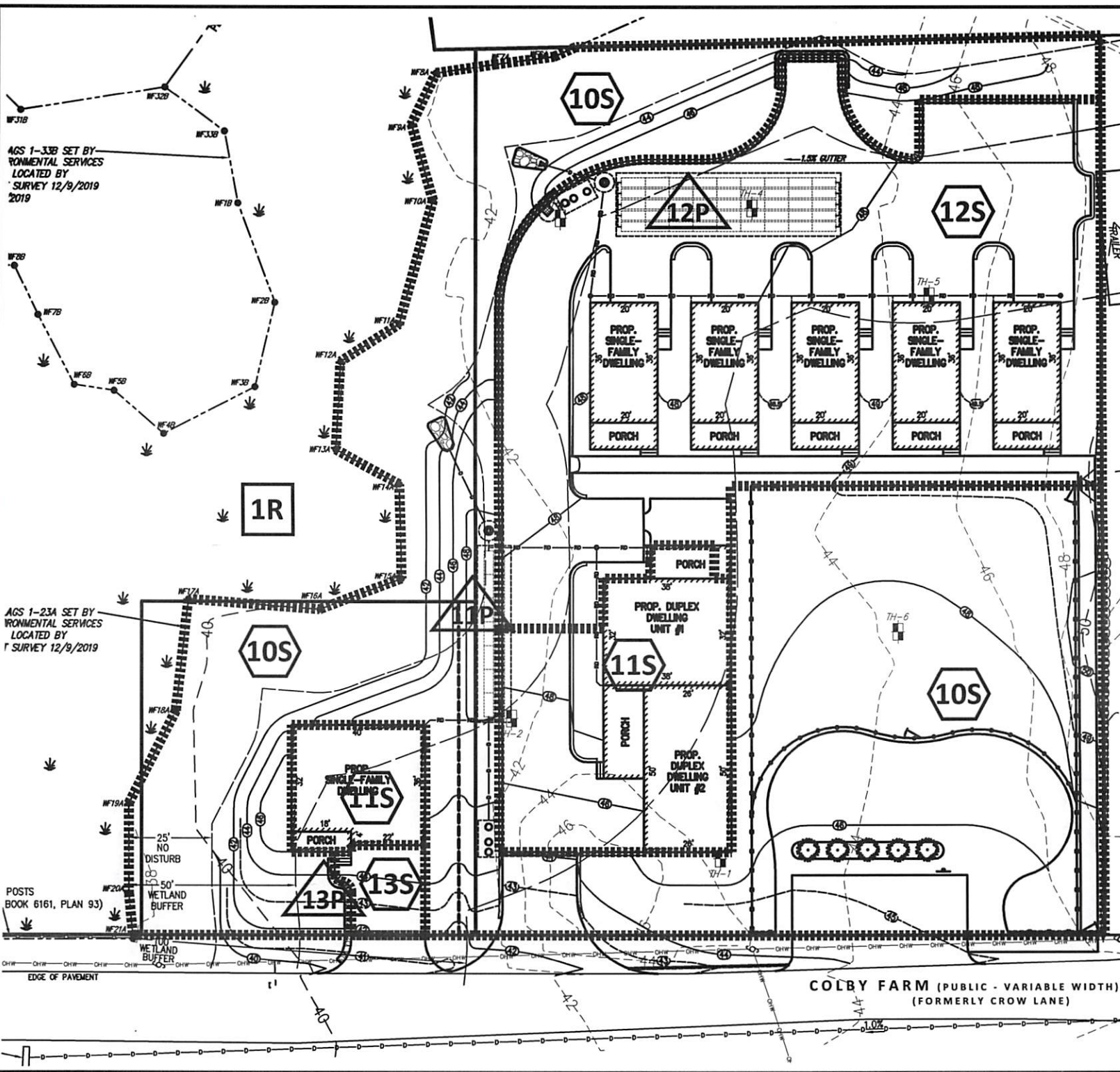

**POST-DEVELOPMENT  
SUBCATCHMENT  
PLAN**

**8, 10, 12, & 18  
COLBY FARM LANE  
NEWBURYPORT  
MASSACHUSETTS**

**APRIL 13, 2020**

PLAN PREPARED FOR:  
**THE DALY GROUP  
225 STEDMAN STREET  
LOWELL, MA 01851**

PLAN PREPARED BY:



**CIVIL ENGINEERING - SURVEYING  
10 GEORGE STREET, UNIT 208  
LOWELL, MASSACHUSETTS 01852  
978-201-9390 - LANDPLEX.COM**

**COLBY FARM (PUBLIC - VARIABLE WIDTH)  
(FORMERLY CROW LANE)**

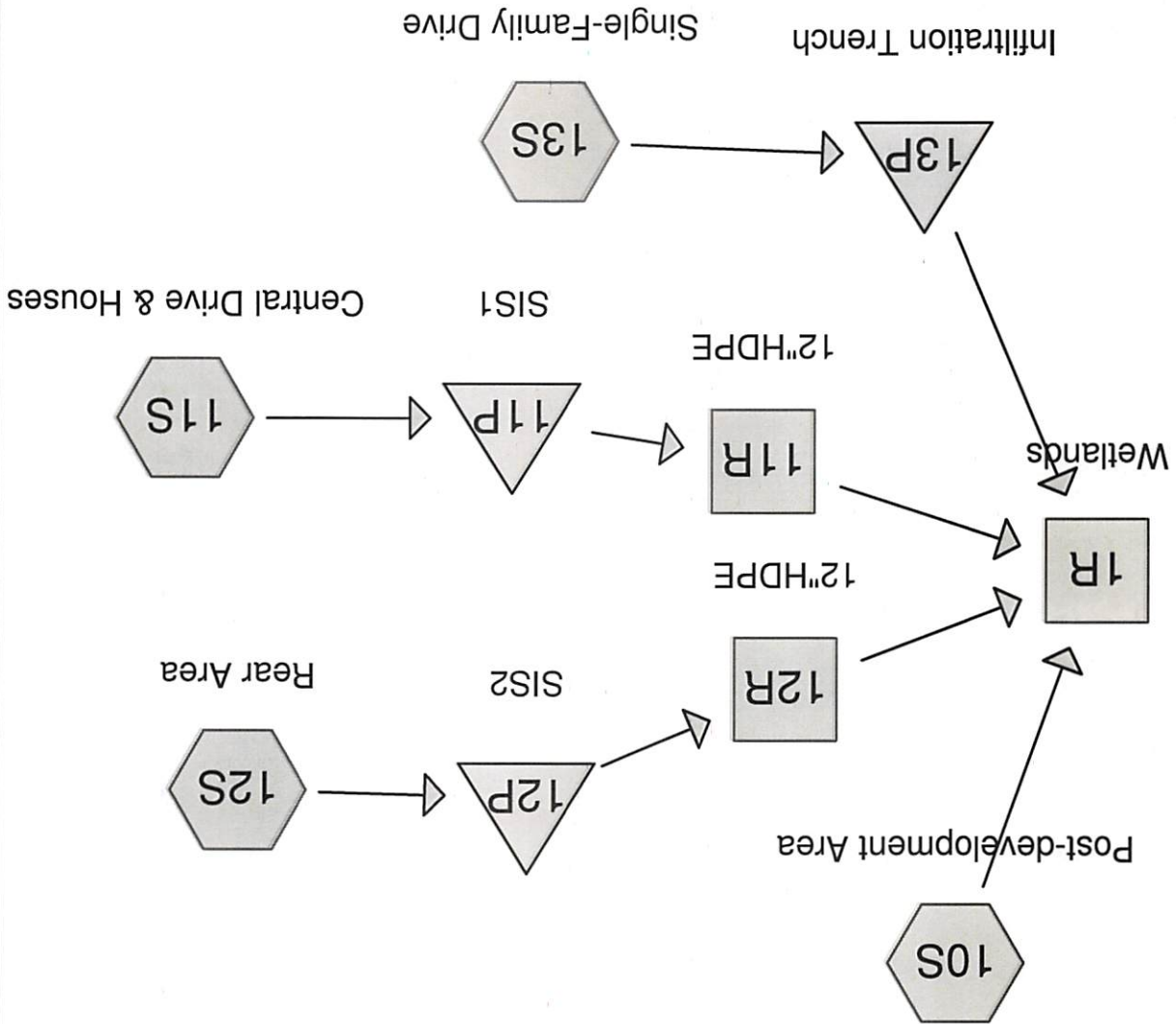
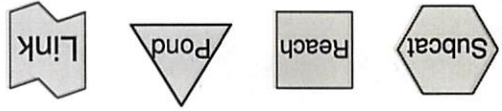



**Subcatchment 10S: Post-development Area**

Runoff = 0.00 cfs @ 24.00 hrs, Volume= 0.000 af, Depth> 0.00"

Runoff by SCS TR-20 method, UH=SCS, Time Span= 0.00-24.00 hrs, dt= 0.05 hrs

Type III 24-hr 2-Year Rainfall=3.10"

Area (sf)	CN	Description
23,715	39	>75% Grass cover, Good, HSG A
8,840	30	Woods, Good, HSG A
2,220	98	Drive entrance, parking, sidewalk
34,775	40	Weighted Average

Tc (min)	Length (feet)	Slope (ft/ft)	Velocity (ft/sec)	Capacity (cfs)	Description
0.1	5	0.0200	0.7		<b>Sheet Flow, Sheet Path</b> Smooth surfaces n= 0.011 P2= 3.10"
4.0	45	0.0400	0.2		<b>Sheet Flow, Sheet Grass</b> Grass: Short n= 0.150 P2= 3.10"
0.8	45	0.0200	1.0		<b>Shallow Concentrated Flow, Shallow Grass</b> Short Grass Pasture Kv= 7.0 fps
0.4	90	0.0400	4.1		<b>Shallow Concentrated Flow, Shallow Smooth</b> Paved Kv= 20.3 fps
0.4	85	0.0300	3.5		<b>Shallow Concentrated Flow, Shallow Smooth</b> Paved Kv= 20.3 fps
1.0	70	0.0300	1.2		<b>Shallow Concentrated Flow, Shallow Grass</b> Short Grass Pasture Kv= 7.0 fps
6.7	340	Total			

**Subcatchment 11S: Central Drive & Houses**

Runoff = 0.44 cfs @ 12.09 hrs, Volume= 0.033 af, Depth> 2.55"

Runoff by SCS TR-20 method, UH=SCS, Time Span= 0.00-24.00 hrs, dt= 0.05 hrs

Type III 24-hr 2-Year Rainfall=3.10"

Area (sf)	CN	Description
1,980	98	Drive, Curbs
3,040	98	Duplex Roof
1,470	98	Single-Family Roof
370	39	>75% Grass cover, Good, HSG A
6,860	95	Weighted Average

Tc (min)	Length (feet)	Slope (ft/ft)	Velocity (ft/sec)	Capacity (cfs)	Description
6.0					<b>Direct Entry,</b>

**Subcatchment 12S: Rear Area**

Runoff = 0.99 cfs @ 12.01 hrs, Volume= 0.062 af, Depth> 1.53"

Runoff by SCS TR-20 method, UH=SCS, Time Span= 0.00-24.00 hrs, dt= 0.05 hrs  
Type III 24-hr 2-Year Rainfall=3.10"

Area (sf)	CN	Description
11,135	98	Pavement, Curbs, Walks
4,680	98	Entrance steps, Roofs
5,260	39	>75% Grass cover, Good, HSG A
21,075	83	Weighted Average

**Subcatchment 13S: Single-Family Drive**

Runoff = 0.04 cfs @ 12.09 hrs, Volume= 0.003 af, Depth> 2.87"

Runoff by SCS TR-20 method, UH=SCS, Time Span= 0.00-24.00 hrs, dt= 0.05 hrs  
Type III 24-hr 2-Year Rainfall=3.10"

Area (sf)	CN	Description
630	98	Driveway

Tc (min)	Length (feet)	Slope (ft/ft)	Velocity (ft/sec)	Capacity (cfs)	Description
6.0					Direct Entry,

**Reach 1R: Wetlands**

Inflow Area = 1.454 ac, Inflow Depth > 0.00" for 2-Year event  
Inflow = 0.00 cfs @ 24.00 hrs, Volume= 0.000 af  
Outflow = 0.00 cfs @ 24.00 hrs, Volume= 0.000 af, Atten= 0%, Lag= 0.0 min

Routing by Dyn-Stor-Ind method, Time Span= 0.00-24.00 hrs, dt= 0.05 hrs

**Reach 11R: 12"HDPE**

Inflow Area = 0.157 ac, Inflow Depth = 0.00" for 2-Year event  
Inflow = 0.00 cfs @ 0.00 hrs, Volume= 0.000 af  
Outflow = 0.00 cfs @ 0.00 hrs, Volume= 0.000 af, Atten= 0%, Lag= 0.0 min

Routing by Dyn-Stor-Ind method, Time Span= 0.00-24.00 hrs, dt= 0.05 hrs  
Max. Velocity= 0.0 fps, Min. Travel Time= 0.0 min  
Avg. Velocity = 0.0 fps, Avg. Travel Time= 0.0 min

# HydroCAD-8Colby-POST

Type III 24-hr 2-Year Rainfall=3.10"

Prepared by {enter your company name here}

Page 4

HydroCAD® 7.10 s/n 003867 © 2005 HydroCAD Software Solutions LLC

4/16/2020

Peak Depth= 0.00' @ 0.00 hrs  
Capacity at bank full= 3.25 cfs  
Inlet Invert= 43.00', Outlet Invert= 42.80'  
12.0" Diameter Pipe, n= 0.013  
Length= 24.0' Slope= 0.0083 '/'

## Reach 12R: 12"HDPE

Inflow Area = 0.484 ac, Inflow Depth = 0.00" for 2-Year event  
Inflow = 0.00 cfs @ 0.00 hrs, Volume= 0.000 af  
Outflow = 0.00 cfs @ 0.00 hrs, Volume= 0.000 af, Atten= 0%, Lag= 0.0 min

Routing by Dyn-Stor-Ind method, Time Span= 0.00-24.00 hrs, dt= 0.05 hrs  
Max. Velocity= 0.0 fps, Min. Travel Time= 0.0 min  
Avg. Velocity = 0.0 fps, Avg. Travel Time= 0.0 min

Peak Depth= 0.00' @ 0.00 hrs  
Capacity at bank full= 2.91 cfs  
Inlet Invert= 44.00', Outlet Invert= 43.90'  
12.0" Diameter Pipe, n= 0.013  
Length= 15.0' Slope= 0.0067 '/'

## Pond 11P: SIS1

Inflow Area = 0.157 ac, Inflow Depth > 2.55" for 2-Year event  
Inflow = 0.44 cfs @ 12.09 hrs, Volume= 0.033 af  
Outflow = 0.10 cfs @ 11.85 hrs, Volume= 0.033 af, Atten= 77%, Lag= 0.0 min  
Discarded = 0.10 cfs @ 11.85 hrs, Volume= 0.033 af  
Primary = 0.00 cfs @ 0.00 hrs, Volume= 0.000 af

Routing by Dyn-Stor-Ind method, Time Span= 0.00-24.00 hrs, dt= 0.05 hrs  
Peak Elev= 42.60' @ 12.48 hrs Surf.Area= 530 sf Storage= 312 cf  
Plug-Flow detention time= (not calculated: outflow precedes inflow)  
Center-of-Mass det. time= 15.5 min ( 797.0 - 781.5 )

Volume	Invert	Avail.Storage	Storage Description
#1	41.50'	411 cf	<b>10.00'W x 53.00'L x 2.33'H Prismatic</b> 1,235 cf Overall - 206 cf Embedded = 1,029 cf x 40.0% Voids
#2	42.00'	206 cf	<b>28.9"W x 16.0"H x 7.12'L StormTech SC-310</b> x 14 Inside #1
		618 cf	Total Available Storage

Device	Routing	Invert	Outlet Devices
#1	Discarded	0.00'	<b>8.270 in/hr Exfiltration over Surface area</b>
#2	Primary	43.00'	<b>12.0" Vert. Orifice/Grate</b> C= 0.600

**Discarded OutFlow** Max=0.10 cfs @ 11.85 hrs HW=41.55' (Free Discharge)  
↑**1=Exfiltration** (Exfiltration Controls 0.10 cfs)

**Primary OutFlow** Max=0.00 cfs @ 0.00 hrs HW=41.50' TW=43.00' (Dynamic Tailwater)  
↑**2=Orifice/Grate** ( Controls 0.00 cfs)

# HydroCAD-8Colby-POST

Type III 24-hr 2-Year Rainfall=3.10"

Prepared by {enter your company name here}

Page 5

HydroCAD® 7.10 s/n 003867 © 2005 HydroCAD Software Solutions LLC

4/16/2020

## Pond 12P: SIS2

Inflow Area = 0.484 ac, Inflow Depth > 1.53" for 2-Year event  
 Inflow = 0.99 cfs @ 12.01 hrs, Volume= 0.062 af  
 Outflow = 0.24 cfs @ 11.90 hrs, Volume= 0.062 af, Atten= 75%, Lag= 0.0 min  
 Discarded = 0.24 cfs @ 11.90 hrs, Volume= 0.062 af  
 Primary = 0.00 cfs @ 0.00 hrs, Volume= 0.000 af

Routing by Dyn-Stor-Ind method, Time Span= 0.00-24.00 hrs, dt= 0.05 hrs  
 Peak Elev= 43.75' @ 12.37 hrs Surf.Area= 1,273 sf Storage= 498 cf  
 Plug-Flow detention time= (not calculated: outflow precedes inflow)  
 Center-of-Mass det. time= 10.2 min ( 839.1 - 828.9 )

Volume	Invert	Avail.Storage	Storage Description
#1	43.00'	921 cf	<b>19.00'W x 67.00'L x 2.33'H Prismatic</b> 2,966 cf Overall - 663 cf Embedded = 2,303 cf x 40.0% Voids
#2	43.50'	663 cf	<b>28.9"W x 16.0"H x 7.12'L StormTech SC-310</b> x 45 Inside #1
		1,584 cf	Total Available Storage

Device	Routing	Invert	Outlet Devices
#1	Discarded	0.00'	<b>8.270 in/hr Exfiltration over Surface area</b>
#2	Primary	44.00'	<b>12.0" Vert. Orifice/Grate</b> C= 0.600

**Discarded OutFlow** Max=0.24 cfs @ 11.90 hrs HW=43.06' (Free Discharge)  
 ↑**1=Exfiltration** (Exfiltration Controls 0.24 cfs)

**Primary OutFlow** Max=0.00 cfs @ 0.00 hrs HW=43.00' TW=44.00' (Dynamic Tailwater)  
 ↑**2=Orifice/Grate** ( Controls 0.00 cfs)

## Pond 13P: Infiltration Trench

Inflow Area = 0.014 ac, Inflow Depth > 2.87" for 2-Year event  
 Inflow = 0.04 cfs @ 12.09 hrs, Volume= 0.003 af  
 Outflow = 0.01 cfs @ 11.90 hrs, Volume= 0.003 af, Atten= 68%, Lag= 0.0 min  
 Discarded = 0.01 cfs @ 11.90 hrs, Volume= 0.003 af  
 Primary = 0.00 cfs @ 0.00 hrs, Volume= 0.000 af

Routing by Dyn-Stor-Ind method, Time Span= 0.00-24.00 hrs, dt= 0.05 hrs  
 Peak Elev= 40.79' @ 12.39 hrs Surf.Area= 70 sf Storage= 22 cf  
 Plug-Flow detention time= (not calculated: outflow precedes inflow)  
 Center-of-Mass det. time= 7.0 min ( 763.6 - 756.6 )

Volume	Invert	Avail.Storage	Storage Description
#1	40.00'	56 cf	<b>2.00'W x 35.00'L x 2.00'H Prismatic</b> 140 cf Overall x 40.0% Voids

Device	Routing	Invert	Outlet Devices
#1	Discarded	0.00'	<b>8.270 in/hr Exfiltration over Surface area</b>
#2	Primary	42.00'	<b>10.0' long x 2.0' breadth Broad-Crested Rectangular Weir</b> Head (feet) 0.20 0.40 0.60 0.80 1.00 1.20 1.40 1.60 1.80 2.00 2.50 3.00 3.50

# HydroCAD-8Colby-POST

Type III 24-hr 2-Year Rainfall=3.10"

Prepared by {enter your company name here}

Page 6

HydroCAD® 7.10 s/n 003867 © 2005 HydroCAD Software Solutions LLC

4/16/2020

Coef. (English) 2.54 2.61 2.61 2.60 2.66 2.70 2.77 2.89 2.88 2.85  
3.07 3.20 3.32

**Discarded OutFlow** Max=0.01 cfs @ 11.90 hrs HW=40.03' (Free Discharge)

↑**1=Exfiltration** (Exfiltration Controls 0.01 cfs)

**Primary OutFlow** Max=0.00 cfs @ 0.00 hrs HW=40.00' TW=0.00' (Dynamic Tailwater)

↑**2=Broad-Crested Rectangular Weir** ( Controls 0.00 cfs)

**Subcatchment 10S: Post-development Area**

Runoff = 0.02 cfs @ 12.51 hrs, Volume= 0.011 af, Depth> 0.17"

Runoff by SCS TR-20 method, UH=SCS, Time Span= 0.00-24.00 hrs, dt= 0.05 hrs  
Type III 24-hr 10-Year Rainfall=4.70"

Area (sf)	CN	Description
23,715	39	>75% Grass cover, Good, HSG A
8,840	30	Woods, Good, HSG A
2,220	98	Drive entrance, parking, sidewalk
34,775	40	Weighted Average

Tc (min)	Length (feet)	Slope (ft/ft)	Velocity (ft/sec)	Capacity (cfs)	Description
0.1	5	0.0200	0.7		<b>Sheet Flow, Sheet Path</b> Smooth surfaces n= 0.011 P2= 3.10"
4.0	45	0.0400	0.2		<b>Sheet Flow, Sheet Grass</b> Grass: Short n= 0.150 P2= 3.10"
0.8	45	0.0200	1.0		<b>Shallow Concentrated Flow, Shallow Grass</b> Short Grass Pasture Kv= 7.0 fps
0.4	90	0.0400	4.1		<b>Shallow Concentrated Flow, Shallow Smooth</b> Paved Kv= 20.3 fps
0.4	85	0.0300	3.5		<b>Shallow Concentrated Flow, Shallow Smooth</b> Paved Kv= 20.3 fps
1.0	70	0.0300	1.2		<b>Shallow Concentrated Flow, Shallow Grass</b> Short Grass Pasture Kv= 7.0 fps
6.7	340	Total			

**Subcatchment 11S: Central Drive & Houses**

Runoff = 0.69 cfs @ 12.09 hrs, Volume= 0.054 af, Depth> 4.12"

Runoff by SCS TR-20 method, UH=SCS, Time Span= 0.00-24.00 hrs, dt= 0.05 hrs  
Type III 24-hr 10-Year Rainfall=4.70"

Area (sf)	CN	Description
1,980	98	Drive, Curbs
3,040	98	Duplex Roof
1,470	98	Single-Family Roof
370	39	>75% Grass cover, Good, HSG A
6,860	95	Weighted Average

Tc (min)	Length (feet)	Slope (ft/ft)	Velocity (ft/sec)	Capacity (cfs)	Description
6.0					<b>Direct Entry,</b>

**HydroCAD-8Colby-POST**

Type III 24-hr 10-Year Rainfall=4.70"

Prepared by {enter your company name here}

Page 8

HydroCAD® 7.10 s/n 003867 © 2005 HydroCAD Software Solutions LLC

4/16/2020

**Subcatchment 12S: Rear Area**

Runoff = 1.89 cfs @ 12.00 hrs, Volume= 0.117 af, Depth&gt; 2.90"

Runoff by SCS TR-20 method, UH=SCS, Time Span= 0.00-24.00 hrs, dt= 0.05 hrs  
Type III 24-hr 10-Year Rainfall=4.70"

Area (sf)	CN	Description
11,135	98	Pavement, Curbs, Walks
4,680	98	Entrance steps, Roofs
5,260	39	>75% Grass cover, Good, HSG A
21,075	83	Weighted Average

**Subcatchment 13S: Single-Family Drive**

Runoff = 0.06 cfs @ 12.09 hrs, Volume= 0.005 af, Depth&gt; 4.46"

Runoff by SCS TR-20 method, UH=SCS, Time Span= 0.00-24.00 hrs, dt= 0.05 hrs  
Type III 24-hr 10-Year Rainfall=4.70"

Area (sf)	CN	Description
630	98	Driveway

Tc (min)	Length (feet)	Slope (ft/ft)	Velocity (ft/sec)	Capacity (cfs)	Description
6.0					Direct Entry,

**Reach 1R: Wetlands**

Inflow Area = 1.454 ac, Inflow Depth &gt; 0.27" for 10-Year event

Inflow = 0.69 cfs @ 12.23 hrs, Volume= 0.032 af

Outflow = 0.69 cfs @ 12.23 hrs, Volume= 0.032 af, Atten= 0%, Lag= 0.0 min

Routing by Dyn-Stor-Ind method, Time Span= 0.00-24.00 hrs, dt= 0.05 hrs

**Reach 11R: 12"HDPE**

Inflow Area = 0.157 ac, Inflow Depth = 0.38" for 10-Year event

Inflow = 0.23 cfs @ 12.24 hrs, Volume= 0.005 af

Outflow = 0.24 cfs @ 12.25 hrs, Volume= 0.005 af, Atten= 0%, Lag= 0.3 min

Routing by Dyn-Stor-Ind method, Time Span= 0.00-24.00 hrs, dt= 0.05 hrs

Max. Velocity= 2.4 fps, Min. Travel Time= 0.2 min

Avg. Velocity = 1.5 fps, Avg. Travel Time= 0.3 min

# HydroCAD-8Colby-POST

Type III 24-hr 10-Year Rainfall=4.70"

Prepared by {enter your company name here}

Page 9

HydroCAD® 7.10 s/n 003867 © 2005 HydroCAD Software Solutions LLC

4/16/2020

Peak Depth= 0.18' @ 12.25 hrs  
Capacity at bank full= 3.25 cfs  
Inlet Invert= 43.00', Outlet Invert= 42.80'  
12.0" Diameter Pipe, n= 0.013  
Length= 24.0' Slope= 0.0083 '/'

## Reach 12R: 12"HDPE

Inflow Area = 0.484 ac, Inflow Depth = 0.39" for 10-Year event  
Inflow = 0.49 cfs @ 12.20 hrs, Volume= 0.016 af  
Outflow = 0.49 cfs @ 12.10 hrs, Volume= 0.016 af, Atten= 1%, Lag= 0.0 min

Routing by Dyn-Stor-Ind method, Time Span= 0.00-24.00 hrs, dt= 0.05 hrs  
Max. Velocity= 2.7 fps, Min. Travel Time= 0.1 min  
Avg. Velocity = 1.7 fps, Avg. Travel Time= 0.1 min

Peak Depth= 0.28' @ 12.10 hrs  
Capacity at bank full= 2.91 cfs  
Inlet Invert= 44.00', Outlet Invert= 43.90'  
12.0" Diameter Pipe, n= 0.013  
Length= 15.0' Slope= 0.0067 '/'

## Pond 11P: SIS1

Inflow Area = 0.157 ac, Inflow Depth > 4.12" for 10-Year event  
Inflow = 0.69 cfs @ 12.09 hrs, Volume= 0.054 af  
Outflow = 0.33 cfs @ 12.24 hrs, Volume= 0.054 af, Atten= 52%, Lag= 9.4 min  
Discarded = 0.10 cfs @ 11.70 hrs, Volume= 0.049 af  
Primary = 0.23 cfs @ 12.24 hrs, Volume= 0.005 af

Routing by Dyn-Stor-Ind method, Time Span= 0.00-24.00 hrs, dt= 0.05 hrs  
Peak Elev= 43.26' @ 12.27 hrs Surf.Area= 530 sf Storage= 496 cf  
Plug-Flow detention time= (not calculated: outflow precedes inflow)  
Center-of-Mass det. time= 22.6 min ( 792.1 - 769.4 )

Volume	Invert	Avail.Storage	Storage Description
#1	41.50'	411 cf	<b>10.00'W x 53.00'L x 2.33'H PrismaToid</b> 1,235 cf Overall - 206 cf Embedded = 1,029 cf x 40.0% Voids
#2	42.00'	206 cf	<b>28.9"W x 16.0"H x 7.12'L StormTech SC-310</b> x 14 Inside #1
		618 cf	Total Available Storage

Device	Routing	Invert	Outlet Devices
#1	Discarded	0.00'	<b>8.270 in/hr Exfiltration over Surface area</b>
#2	Primary	43.00'	<b>12.0" Vert. Orifice/Grate</b> C= 0.600

**Discarded OutFlow** Max=0.10 cfs @ 11.70 hrs HW=41.53' (Free Discharge)

↑**1=Exfiltration** (Exfiltration Controls 0.10 cfs)

**Primary OutFlow** Max=0.19 cfs @ 12.24 hrs HW=43.25' TW=43.18' (Dynamic Tailwater)

↑**2=Orifice/Grate** (Orifice Controls 0.19 cfs @ 1.2 fps)



# HydroCAD-8Colby-POST

Type III 24-hr 10-Year Rainfall=4.70"

Prepared by {enter your company name here}

Page 10

HydroCAD® 7.10 s/n 003867 © 2005 HydroCAD Software Solutions LLC

4/16/2020

## Pond 12P: SIS2

Inflow Area = 0.484 ac, Inflow Depth > 2.90" for 10-Year event  
 Inflow = 1.89 cfs @ 12.00 hrs, Volume= 0.117 af  
 Outflow = 0.73 cfs @ 12.20 hrs, Volume= 0.117 af, Atten= 61%, Lag= 11.8 min  
 Discarded = 0.24 cfs @ 11.65 hrs, Volume= 0.101 af  
 Primary = 0.49 cfs @ 12.20 hrs, Volume= 0.016 af

Routing by Dyn-Stor-Ind method, Time Span= 0.00-24.00 hrs, dt= 0.05 hrs  
 Peak Elev= 44.39' @ 12.20 hrs Surf.Area= 1,273 sf Storage= 1,052 cf  
 Plug-Flow detention time= (not calculated: outflow precedes inflow)  
 Center-of-Mass det. time= 18.7 min ( 829.2 - 810.4 )

Volume	Invert	Avail.Storage	Storage Description
#1	43.00'	921 cf	<b>19.00'W x 67.00'L x 2.33'H Prismaoid</b> 2,966 cf Overall - 663 cf Embedded = 2,303 cf x 40.0% Voids
#2	43.50'	663 cf	<b>28.9"W x 16.0"H x 7.12'L StormTech SC-310</b> x 45 Inside #1
		1,584 cf	Total Available Storage

Device	Routing	Invert	Outlet Devices
#1	Discarded	0.00'	<b>8.270 in/hr Exfiltration over Surface area</b>
#2	Primary	44.00'	<b>12.0" Vert. Orifice/Grate</b> C= 0.600

**Discarded OutFlow** Max=0.24 cfs @ 11.65 hrs HW=43.03' (Free Discharge)  
 ↑**1=Exfiltration** (Exfiltration Controls 0.24 cfs)

**Primary OutFlow** Max=0.46 cfs @ 12.20 hrs HW=44.39' TW=44.28' (Dynamic Tailwater)  
 ↑**2=Orifice/Grate** (Orifice Controls 0.46 cfs @ 1.6 fps)

## Pond 13P: Infiltration Trench

Inflow Area = 0.014 ac, Inflow Depth > 4.46" for 10-Year event  
 Inflow = 0.06 cfs @ 12.09 hrs, Volume= 0.005 af  
 Outflow = 0.01 cfs @ 11.75 hrs, Volume= 0.005 af, Atten= 79%, Lag= 0.0 min  
 Discarded = 0.01 cfs @ 11.75 hrs, Volume= 0.005 af  
 Primary = 0.00 cfs @ 0.00 hrs, Volume= 0.000 af

Routing by Dyn-Stor-Ind method, Time Span= 0.00-24.00 hrs, dt= 0.05 hrs  
 Peak Elev= 41.85' @ 12.51 hrs Surf.Area= 70 sf Storage= 52 cf  
 Plug-Flow detention time= (not calculated: outflow precedes inflow)  
 Center-of-Mass det. time= 18.8 min ( 767.4 - 748.6 )

Volume	Invert	Avail.Storage	Storage Description
#1	40.00'	56 cf	<b>2.00'W x 35.00'L x 2.00'H Prismaoid</b> 140 cf Overall x 40.0% Voids

Device	Routing	Invert	Outlet Devices
#1	Discarded	0.00'	<b>8.270 in/hr Exfiltration over Surface area</b>
#2	Primary	42.00'	<b>10.0' long x 2.0' breadth Broad-Crested Rectangular Weir</b> Head (feet) 0.20 0.40 0.60 0.80 1.00 1.20 1.40 1.60 1.80 2.00 2.50 3.00 3.50

**HydroCAD-8Colby-POST**

Type III 24-hr 10-Year Rainfall=4.70"

Prepared by {enter your company name here}

Page 11

HydroCAD® 7.10 s/n 003867 © 2005 HydroCAD Software Solutions LLC

4/16/2020

Coef. (English) 2.54 2.61 2.61 2.60 2.66 2.70 2.77 2.89 2.88 2.85  
3.07 3.20 3.32

**Discarded OutFlow** Max=0.01 cfs @ 11.75 hrs HW=40.02' (Free Discharge)

↑**1=Exfiltration** (Exfiltration Controls 0.01 cfs)

**Primary OutFlow** Max=0.00 cfs @ 0.00 hrs HW=40.00' TW=0.00' (Dynamic Tailwater)

↑**2=Broad-Crested Rectangular Weir** ( Controls 0.00 cfs)

# HydroCAD-8Colby-POST

Type III 24-hr 25-year Rainfall=5.80"

Prepared by {enter your company name here}

Page 12

HydroCAD® 7.10 s/n 003867 © 2005 HydroCAD Software Solutions LLC

4/16/2020

## Subcatchment 10S: Post-development Area

Runoff = 0.14 cfs @ 12.35 hrs, Volume= 0.029 af, Depth> 0.44"

Runoff by SCS TR-20 method, UH=SCS, Time Span= 0.00-24.00 hrs, dt= 0.05 hrs  
Type III 24-hr 25-year Rainfall=5.80"

Area (sf)	CN	Description
23,715	39	>75% Grass cover, Good, HSG A
8,840	30	Woods, Good, HSG A
2,220	98	Drive entrance, parking, sidewalk
34,775	40	Weighted Average

Tc (min)	Length (feet)	Slope (ft/ft)	Velocity (ft/sec)	Capacity (cfs)	Description
0.1	5	0.0200	0.7		<b>Sheet Flow, Sheet Path</b> Smooth surfaces n= 0.011 P2= 3.10"
4.0	45	0.0400	0.2		<b>Sheet Flow, Sheet Grass</b> Grass: Short n= 0.150 P2= 3.10"
0.8	45	0.0200	1.0		<b>Shallow Concentrated Flow, Shallow Grass</b> Short Grass Pasture Kv= 7.0 fps
0.4	90	0.0400	4.1		<b>Shallow Concentrated Flow, Shallow Smooth</b> Paved Kv= 20.3 fps
0.4	85	0.0300	3.5		<b>Shallow Concentrated Flow, Shallow Smooth</b> Paved Kv= 20.3 fps
1.0	70	0.0300	1.2		<b>Shallow Concentrated Flow, Shallow Grass</b> Short Grass Pasture Kv= 7.0 fps
6.7	340	Total			

## Subcatchment 11S: Central Drive & Houses

Runoff = 0.86 cfs @ 12.09 hrs, Volume= 0.068 af, Depth> 5.21"

Runoff by SCS TR-20 method, UH=SCS, Time Span= 0.00-24.00 hrs, dt= 0.05 hrs  
Type III 24-hr 25-year Rainfall=5.80"

Area (sf)	CN	Description
1,980	98	Drive, Curbs
3,040	98	Duplex Roof
1,470	98	Single-Family Roof
370	39	>75% Grass cover, Good, HSG A
6,860	95	Weighted Average

Tc (min)	Length (feet)	Slope (ft/ft)	Velocity (ft/sec)	Capacity (cfs)	Description
6.0					<b>Direct Entry,</b>

**Subcatchment 12S: Rear Area**

Runoff = 2.52 cfs @ 12.00 hrs, Volume= 0.157 af, Depth> 3.91"

Runoff by SCS TR-20 method, UH=SCS, Time Span= 0.00-24.00 hrs, dt= 0.05 hrs  
Type III 24-hr 25-year Rainfall=5.80"

Area (sf)	CN	Description
11,135	98	Pavement, Curbs, Walks
4,680	98	Entrance steps, Roofs
5,260	39	>75% Grass cover, Good, HSG A
21,075	83	Weighted Average

**Subcatchment 13S: Single-Family Drive**

Runoff = 0.08 cfs @ 12.09 hrs, Volume= 0.007 af, Depth> 5.56"

Runoff by SCS TR-20 method, UH=SCS, Time Span= 0.00-24.00 hrs, dt= 0.05 hrs  
Type III 24-hr 25-year Rainfall=5.80"

Area (sf)	CN	Description
630	98	Driveway

Tc (min)	Length (feet)	Slope (ft/ft)	Velocity (ft/sec)	Capacity (cfs)	Description
6.0					Direct Entry,

**Reach 1R: Wetlands**

Inflow Area = 1.454 ac, Inflow Depth > 0.63" for 25-year event  
Inflow = 1.67 cfs @ 12.15 hrs, Volume= 0.076 af  
Outflow = 1.67 cfs @ 12.15 hrs, Volume= 0.076 af, Atten= 0%, Lag= 0.0 min

Routing by Dyn-Stor-Ind method, Time Span= 0.00-24.00 hrs, dt= 0.05 hrs

**Reach 11R: 12"HDPE**

Inflow Area = 0.157 ac, Inflow Depth = 0.85" for 25-year event  
Inflow = 0.64 cfs @ 12.16 hrs, Volume= 0.011 af  
Outflow = 0.62 cfs @ 12.16 hrs, Volume= 0.011 af, Atten= 2%, Lag= 0.2 min

Routing by Dyn-Stor-Ind method, Time Span= 0.00-24.00 hrs, dt= 0.05 hrs  
Max. Velocity= 3.2 fps, Min. Travel Time= 0.1 min  
Avg. Velocity = 1.7 fps, Avg. Travel Time= 0.2 min

# HydroCAD-8Colby-POST

Type III 24-hr 25-year Rainfall=5.80"

Prepared by {enter your company name here}

Page 14

HydroCAD® 7.10 s/n 003867 © 2005 HydroCAD Software Solutions LLC

4/16/2020

Peak Depth= 0.30' @ 12.16 hrs  
Capacity at bank full= 3.25 cfs  
Inlet Invert= 43.00', Outlet Invert= 42.80'  
12.0" Diameter Pipe, n= 0.013  
Length= 24.0' Slope= 0.0083 '/'

## Reach 12R: 12"HDPE

Inflow Area = 0.484 ac, Inflow Depth = 0.88" for 25-year event  
Inflow = 1.39 cfs @ 12.06 hrs, Volume= 0.035 af  
Outflow = 1.39 cfs @ 12.06 hrs, Volume= 0.035 af, Atten= 0%, Lag= 0.1 min

Routing by Dyn-Stor-Ind method, Time Span= 0.00-24.00 hrs, dt= 0.05 hrs  
Max. Velocity= 3.6 fps, Min. Travel Time= 0.1 min  
Avg. Velocity = 2.0 fps, Avg. Travel Time= 0.1 min

Peak Depth= 0.49' @ 12.07 hrs  
Capacity at bank full= 2.91 cfs  
Inlet Invert= 44.00', Outlet Invert= 43.90'  
12.0" Diameter Pipe, n= 0.013  
Length= 15.0' Slope= 0.0067 '/'

## Pond 11P: SIS1

Inflow Area = 0.157 ac, Inflow Depth > 5.21" for 25-year event  
Inflow = 0.86 cfs @ 12.09 hrs, Volume= 0.068 af  
Outflow = 0.74 cfs @ 12.16 hrs, Volume= 0.068 af, Atten= 14%, Lag= 4.3 min  
Discarded = 0.10 cfs @ 11.65 hrs, Volume= 0.057 af  
Primary = 0.64 cfs @ 12.16 hrs, Volume= 0.011 af

Routing by Dyn-Stor-Ind method, Time Span= 0.00-24.00 hrs, dt= 0.05 hrs  
Peak Elev= 43.42' @ 12.17 hrs Surf.Area= 530 sf Storage= 531 cf  
Plug-Flow detention time= (not calculated: outflow precedes inflow)  
Center-of-Mass det. time= 21.0 min ( 785.0 - 764.0 )

Volume	Invert	Avail.Storage	Storage Description
#1	41.50'	411 cf	<b>10.00'W x 53.00'L x 2.33'H Prismatic</b> 1,235 cf Overall - 206 cf Embedded = 1,029 cf x 40.0% Voids
#2	42.00'	206 cf	<b>28.9"W x 16.0"H x 7.12'L StormTech SC-310</b> x 14 Inside #1
		618 cf	Total Available Storage

Device	Routing	Invert	Outlet Devices
#1	Discarded	0.00'	<b>8.270 in/hr Exfiltration over Surface area</b>
#2	Primary	43.00'	<b>12.0" Vert. Orifice/Grate</b> C= 0.600

**Discarded OutFlow** Max=0.10 cfs @ 11.65 hrs HW=41.54' (Free Discharge)

↑1=Exfiltration (Exfiltration Controls 0.10 cfs)

**Primary OutFlow** Max=0.46 cfs @ 12.16 hrs HW=43.39' TW=43.28' (Dynamic Tailwater)

↑2=Orifice/Grate (Orifice Controls 0.46 cfs @ 1.6 fps)

# HydroCAD-8Colby-POST

Type III 24-hr 25-year Rainfall=5.80"

Prepared by {enter your company name here}

Page 15

HydroCAD® 7.10 s/n 003867 © 2005 HydroCAD Software Solutions LLC

4/16/2020

## Pond 12P: SIS2

Inflow Area = 0.484 ac, Inflow Depth > 3.91" for 25-year event  
 Inflow = 2.52 cfs @ 12.00 hrs, Volume= 0.157 af  
 Outflow = 1.63 cfs @ 12.06 hrs, Volume= 0.158 af, Atten= 35%, Lag= 3.7 min  
 Discarded = 0.24 cfs @ 11.60 hrs, Volume= 0.122 af  
 Primary = 1.39 cfs @ 12.06 hrs, Volume= 0.035 af

Routing by Dyn-Stor-Ind method, Time Span= 0.00-24.00 hrs, dt= 0.05 hrs  
 Peak Elev= 44.65' @ 12.10 hrs Surf.Area= 1,273 sf Storage= 1,231 cf  
 Plug-Flow detention time= (not calculated: outflow precedes inflow)  
 Center-of-Mass det. time= 17.9 min ( 819.8 - 802.0 )

Volume	Invert	Avail.Storage	Storage Description
#1	43.00'	921 cf	<b>19.00'W x 67.00'L x 2.33'H PrismaToid</b> 2,966 cf Overall - 663 cf Embedded = 2,303 cf x 40.0% Voids
#2	43.50'	663 cf	<b>28.9"W x 16.0"H x 7.12'L StormTech SC-310</b> x 45 Inside #1
		1,584 cf	Total Available Storage

Device	Routing	Invert	Outlet Devices
#1	Discarded	0.00'	<b>8.270 in/hr Exfiltration over Surface area</b>
#2	Primary	44.00'	<b>12.0" Vert. Orifice/Grate</b> C= 0.600

**Discarded OutFlow** Max=0.24 cfs @ 11.60 hrs HW=43.04' (Free Discharge)  
 ↑**1=Exfiltration** (Exfiltration Controls 0.24 cfs)

**Primary OutFlow** Max=0.99 cfs @ 12.06 hrs HW=44.62' TW=44.46' (Dynamic Tailwater)  
 ↑**2=Orifice/Grate** (Orifice Controls 0.99 cfs @ 1.9 fps)

## Pond 13P: Infiltration Trench

Inflow Area = 0.014 ac, Inflow Depth > 5.56" for 25-year event  
 Inflow = 0.08 cfs @ 12.09 hrs, Volume= 0.007 af  
 Outflow = 0.06 cfs @ 12.25 hrs, Volume= 0.007 af, Atten= 25%, Lag= 9.6 min  
 Discarded = 0.01 cfs @ 11.70 hrs, Volume= 0.006 af  
 Primary = 0.05 cfs @ 12.25 hrs, Volume= 0.000 af

Routing by Dyn-Stor-Ind method, Time Span= 0.00-24.00 hrs, dt= 0.05 hrs  
 Peak Elev= 42.01' @ 12.25 hrs Surf.Area= 70 sf Storage= 56 cf  
 Plug-Flow detention time= (not calculated: outflow precedes inflow)  
 Center-of-Mass det. time= 19.7 min ( 764.9 - 745.2 )

Volume	Invert	Avail.Storage	Storage Description
#1	40.00'	56 cf	<b>2.00'W x 35.00'L x 2.00'H PrismaToid</b> 140 cf Overall x 40.0% Voids

Device	Routing	Invert	Outlet Devices
#1	Discarded	0.00'	<b>8.270 in/hr Exfiltration over Surface area</b>
#2	Primary	42.00'	<b>10.0' long x 2.0' breadth Broad-Crested Rectangular Weir</b> Head (feet) 0.20 0.40 0.60 0.80 1.00 1.20 1.40 1.60 1.80 2.00 2.50 3.00 3.50

**HydroCAD-8Colby-POST**

Type III 24-hr 25-year Rainfall=5.80"

Prepared by {enter your company name here}

Page 16

HydroCAD® 7.10 s/n 003867 © 2005 HydroCAD Software Solutions LLC

4/16/2020

Coef. (English) 2.54 2.61 2.61 2.60 2.66 2.70 2.77 2.89 2.88 2.85  
3.07 3.20 3.32

**Discarded OutFlow** Max=0.01 cfs @ 11.70 hrs HW=40.02' (Free Discharge)

↑1=Exfiltration (Exfiltration Controls 0.01 cfs)

**Primary OutFlow** Max=0.04 cfs @ 12.25 hrs HW=42.01' TW=0.00' (Dynamic Tailwater)

↑2=Broad-Crested Rectangular Weir (Weir Controls 0.04 cfs @ 0.3 fps)

**HydroCAD-8Colby-POST**

Type III 24-hr 100-Year Rainfall=8.30"

Prepared by {enter your company name here}

Page 17

HydroCAD® 7.10 s/n 003867 © 2005 HydroCAD Software Solutions LLC

4/16/2020

**Subcatchment 10S: Post-development Area**

Runoff = 0.88 cfs @ 12.13 hrs, Volume= 0.092 af, Depth&gt; 1.38"

Runoff by SCS TR-20 method, UH=SCS, Time Span= 0.00-24.00 hrs, dt= 0.05 hrs  
Type III 24-hr 100-Year Rainfall=8.30"

Area (sf)	CN	Description
23,715	39	>75% Grass cover, Good, HSG A
8,840	30	Woods, Good, HSG A
2,220	98	Drive entrance, parking, sidewalk
34,775	40	Weighted Average

Tc (min)	Length (feet)	Slope (ft/ft)	Velocity (ft/sec)	Capacity (cfs)	Description
0.1	5	0.0200	0.7		<b>Sheet Flow, Sheet Path</b> Smooth surfaces n= 0.011 P2= 3.10"
4.0	45	0.0400	0.2		<b>Sheet Flow, Sheet Grass</b> Grass: Short n= 0.150 P2= 3.10"
0.8	45	0.0200	1.0		<b>Shallow Concentrated Flow, Shallow Grass</b> Short Grass Pasture Kv= 7.0 fps
0.4	90	0.0400	4.1		<b>Shallow Concentrated Flow, Shallow Smooth</b> Paved Kv= 20.3 fps
0.4	85	0.0300	3.5		<b>Shallow Concentrated Flow, Shallow Smooth</b> Paved Kv= 20.3 fps
1.0	70	0.0300	1.2		<b>Shallow Concentrated Flow, Shallow Grass</b> Short Grass Pasture Kv= 7.0 fps
6.7	340	Total			

**Subcatchment 11S: Central Drive & Houses**

Runoff = 1.24 cfs @ 12.09 hrs, Volume= 0.101 af, Depth&gt; 7.70"

Runoff by SCS TR-20 method, UH=SCS, Time Span= 0.00-24.00 hrs, dt= 0.05 hrs  
Type III 24-hr 100-Year Rainfall=8.30"

Area (sf)	CN	Description
1,980	98	Drive, Curbs
3,040	98	Duplex Roof
1,470	98	Single-Family Roof
370	39	>75% Grass cover, Good, HSG A
6,860	95	Weighted Average

Tc (min)	Length (feet)	Slope (ft/ft)	Velocity (ft/sec)	Capacity (cfs)	Description
6.0					<b>Direct Entry,</b>



## HydroCAD-8Colby-POST

Type III 24-hr 100-Year Rainfall=8.30"

Prepared by {enter your company name here}

Page 18

HydroCAD® 7.10 s/n 003867 © 2005 HydroCAD Software Solutions LLC

4/16/2020

### Subcatchment 12S: Rear Area

Runoff = 3.96 cfs @ 12.00 hrs, Volume= 0.253 af, Depth> 6.26"

Runoff by SCS TR-20 method, UH=SCS, Time Span= 0.00-24.00 hrs, dt= 0.05 hrs  
Type III 24-hr 100-Year Rainfall=8.30"

Area (sf)	CN	Description
11,135	98	Pavement, Curbs, Walks
4,680	98	Entrance steps, Roofs
5,260	39	>75% Grass cover, Good, HSG A
21,075	83	Weighted Average

### Subcatchment 13S: Single-Family Drive

Runoff = 0.12 cfs @ 12.09 hrs, Volume= 0.010 af, Depth> 8.06"

Runoff by SCS TR-20 method, UH=SCS, Time Span= 0.00-24.00 hrs, dt= 0.05 hrs  
Type III 24-hr 100-Year Rainfall=8.30"

Area (sf)	CN	Description
630	98	Driveway

Tc (min)	Length (feet)	Slope (ft/ft)	Velocity (ft/sec)	Capacity (cfs)	Description
6.0					Direct Entry,

### Reach 1R: Wetlands

Inflow Area = 1.454 ac, Inflow Depth > 1.70" for 100-Year event

Inflow = 4.46 cfs @ 12.09 hrs, Volume= 0.206 af

Outflow = 4.46 cfs @ 12.09 hrs, Volume= 0.206 af, Atten= 0%, Lag= 0.0 min

Routing by Dyn-Stor-Ind method, Time Span= 0.00-24.00 hrs, dt= 0.05 hrs

### Reach 11R: 12"HDPE

Inflow Area = 0.157 ac, Inflow Depth = 2.02" for 100-Year event

Inflow = 1.08 cfs @ 12.10 hrs, Volume= 0.027 af

Outflow = 1.11 cfs @ 12.10 hrs, Volume= 0.027 af, Atten= 0%, Lag= 0.0 min

Routing by Dyn-Stor-Ind method, Time Span= 0.00-24.00 hrs, dt= 0.05 hrs

Max. Velocity= 3.7 fps, Min. Travel Time= 0.1 min

Avg. Velocity = 1.9 fps, Avg. Travel Time= 0.2 min

# HydroCAD-8Colby-POST

Type III 24-hr 100-Year Rainfall=8.30"

Prepared by {enter your company name here}

Page 19

HydroCAD® 7.10 s/n 003867 © 2005 HydroCAD Software Solutions LLC

4/16/2020

Peak Depth= 0.40' @ 12.10 hrs  
Capacity at bank full= 3.25 cfs  
Inlet Invert= 43.00', Outlet Invert= 42.80'  
12.0" Diameter Pipe, n= 0.013  
Length= 24.0' Slope= 0.0083 '/'

## Reach 12R: 12"HDPE

Inflow Area = 0.484 ac, Inflow Depth = 2.12" for 100-Year event  
Inflow = 2.83 cfs @ 12.02 hrs, Volume= 0.086 af  
Outflow = 2.82 cfs @ 12.02 hrs, Volume= 0.086 af, Atten= 0%, Lag= 0.1 min

Routing by Dyn-Stor-Ind method, Time Span= 0.00-24.00 hrs, dt= 0.05 hrs  
Max. Velocity= 4.2 fps, Min. Travel Time= 0.1 min  
Avg. Velocity = 2.1 fps, Avg. Travel Time= 0.1 min

Peak Depth= 0.79' @ 12.02 hrs  
Capacity at bank full= 2.91 cfs  
Inlet Invert= 44.00', Outlet Invert= 43.90'  
12.0" Diameter Pipe, n= 0.013  
Length= 15.0' Slope= 0.0067 '/'

## Pond 11P: SIS1

Inflow Area = 0.157 ac, Inflow Depth > 7.70" for 100-Year event  
Inflow = 1.24 cfs @ 12.09 hrs, Volume= 0.101 af  
Outflow = 1.18 cfs @ 12.10 hrs, Volume= 0.101 af, Atten= 5%, Lag= 1.0 min  
Discarded = 0.10 cfs @ 11.35 hrs, Volume= 0.074 af  
Primary = 1.08 cfs @ 12.10 hrs, Volume= 0.027 af

Routing by Dyn-Stor-Ind method, Time Span= 0.00-24.00 hrs, dt= 0.05 hrs  
Peak Elev= 43.58' @ 12.12 hrs Surf.Area= 530 sf Storage= 566 cf  
Plug-Flow detention time= (not calculated: outflow precedes inflow)  
Center-of-Mass det. time= 19.7 min ( 775.5 - 755.9 )

Volume	Invert	Avail.Storage	Storage Description
#1	41.50'	411 cf	<b>10.00'W x 53.00'L x 2.33'H PrismaToid</b> 1,235 cf Overall - 206 cf Embedded = 1,029 cf x 40.0% Voids
#2	42.00'	206 cf	<b>28.9"W x 16.0"H x 7.12'L StormTech SC-310</b> x 14 Inside #1
		618 cf	Total Available Storage

Device	Routing	Invert	Outlet Devices
#1	Discarded	0.00'	<b>8.270 in/hr Exfiltration over Surface area</b>
#2	Primary	43.00'	<b>12.0" Vert. Orifice/Grate</b> C= 0.600

**Discarded OutFlow** Max=0.10 cfs @ 11.35 hrs HW=41.53' (Free Discharge)  
↑1=Exfiltration (Exfiltration Controls 0.10 cfs)

**Primary OutFlow** Max=0.94 cfs @ 12.10 hrs HW=43.57' TW=43.40' (Dynamic Tailwater)  
↑2=Orifice/Grate (Orifice Controls 0.94 cfs @ 2.0 fps)

# HydroCAD-8Colby-POST

Type III 24-hr 100-Year Rainfall=8.30"

Prepared by {enter your company name here}

Page 20

HydroCAD® 7.10 s/n 003867 © 2005 HydroCAD Software Solutions LLC

4/16/2020

## Pond 12P: SIS2

Inflow Area = 0.484 ac, Inflow Depth > 6.26" for 100-Year event  
 Inflow = 3.96 cfs @ 12.00 hrs, Volume= 0.253 af  
 Outflow = 3.07 cfs @ 12.02 hrs, Volume= 0.253 af, Atten= 22%, Lag= 1.1 min  
 Discarded = 0.24 cfs @ 11.30 hrs, Volume= 0.167 af  
 Primary = 2.83 cfs @ 12.02 hrs, Volume= 0.086 af

Routing by Dyn-Stor-Ind method, Time Span= 0.00-24.00 hrs, dt= 0.05 hrs  
 Peak Elev= 45.24' @ 12.06 hrs Surf.Area= 1,273 sf Storage= 1,537 cf  
 Plug-Flow detention time= (not calculated: outflow precedes inflow)  
 Center-of-Mass det. time= 17.1 min ( 805.8 - 788.8 )

Volume	Invert	Avail.Storage	Storage Description
#1	43.00'	921 cf	<b>19.00'W x 67.00'L x 2.33'H Prismatic</b> 2,966 cf Overall - 663 cf Embedded = 2,303 cf x 40.0% Voids
#2	43.50'	663 cf	<b>28.9"W x 16.0"H x 7.12'L StormTech SC-310</b> x 45 Inside #1
		1,584 cf	Total Available Storage

Device	Routing	Invert	Outlet Devices
#1	Discarded	0.00'	<b>8.270 in/hr Exfiltration over Surface area</b>
#2	Primary	44.00'	<b>12.0" Vert. Orifice/Grate</b> C= 0.600

**Discarded OutFlow** Max=0.24 cfs @ 11.30 hrs HW=43.03' (Free Discharge)  
 ↑1=Exfiltration (Exfiltration Controls 0.24 cfs)

**Primary OutFlow** Max=2.25 cfs @ 12.02 hrs HW=45.11' TW=44.75' (Dynamic Tailwater)  
 ↑2=Orifice/Grate (Orifice Controls 2.25 cfs @ 2.9 fps)

## Pond 13P: Infiltration Trench

Inflow Area = 0.014 ac, Inflow Depth > 8.06" for 100-Year event  
 Inflow = 0.12 cfs @ 12.09 hrs, Volume= 0.010 af  
 Outflow = 0.14 cfs @ 12.11 hrs, Volume= 0.010 af, Atten= 0%, Lag= 1.2 min  
 Discarded = 0.01 cfs @ 11.65 hrs, Volume= 0.008 af  
 Primary = 0.12 cfs @ 12.11 hrs, Volume= 0.002 af

Routing by Dyn-Stor-Ind method, Time Span= 0.00-24.00 hrs, dt= 0.05 hrs  
 Peak Elev= 42.03' @ 12.10 hrs Surf.Area= 70 sf Storage= 56 cf  
 Plug-Flow detention time= (not calculated: outflow precedes inflow)  
 Center-of-Mass det. time= 17.7 min ( 758.1 - 740.3 )

Volume	Invert	Avail.Storage	Storage Description
#1	40.00'	56 cf	<b>2.00'W x 35.00'L x 2.00'H Prismatic</b> 140 cf Overall x 40.0% Voids

Device	Routing	Invert	Outlet Devices
#1	Discarded	0.00'	<b>8.270 in/hr Exfiltration over Surface area</b>
#2	Primary	42.00'	<b>10.0' long x 2.0' breadth Broad-Crested Rectangular Weir</b> Head (feet) 0.20 0.40 0.60 0.80 1.00 1.20 1.40 1.60 1.80 2.00 2.50 3.00 3.50

**HydroCAD-8Colby-POST**

Type III 24-hr 100-Year Rainfall=8.30"

Prepared by {enter your company name here}

Page 21

HydroCAD® 7.10 s/n 003867 © 2005 HydroCAD Software Solutions LLC

4/16/2020

Coef. (English) 2.54 2.61 2.61 2.60 2.66 2.70 2.77 2.89 2.88 2.85  
3.07 3.20 3.32

**Discarded OutFlow** Max=0.01 cfs @ 11.65 hrs HW=40.05' (Free Discharge)

↑1=Exfiltration (Exfiltration Controls 0.01 cfs)

**Primary OutFlow** Max=0.11 cfs @ 12.11 hrs HW=42.03' TW=0.00' (Dynamic Tailwater)

↑2=Broad-Crested Rectangular Weir (Weir Controls 0.11 cfs @ 0.4 fps)

**SECTION 4: CONSTRUCTION-PERIOD, OPERATION &  
MAINTENANCE, AND LONG-TERM POLLUTION  
PREVENTION PLAN**

## **SECTION 4.1 - INTRODUCTION**

The following Operation and Maintenance plan provides the requirements for the proposed storm water management system throughout the construction phase and the post development period of the system. The maintenance standards presented are based on recommended design and maintenance standards in *Managing Stormwater in Massachusetts, Volume One: Stormwater Handbook, Prepared by: MA Department of Environmental Protection*

These operations and maintenance procedures are required for proper operation of the stormwater management system; additional procedures may also be developed as the system is operated over a period of time. As with all stormwater facilities, the conditions may change or the management may be simplified as the maintenance personnel become more familiar with them. For example, as detention facilities mature, the ability for the basins to remove pollutants, and the efficiency increases, and therefore, the frequency of inspection may need to be adjusted.

Proper maintenance is essential to ensure that the performance of the system meets the design expectation. A system that is not maintained will inevitably fail and could lead to financial loss, damage to surrounding infrastructure or environmentally sensitive areas, and an increase in the liability of the property owner. The three keys to maintaining a functional storm water management system are *personnel, education, and record keeping*.

*Personnel* make the difference between a Stormwater Management System that performs as designed throughout its lifetime or one that fails due to lack of attention. *Education* provides the personnel with the skills needed to effectively maintain a Stormwater Management System. *Record Keeping* allows the personnel to track the maintenance and the performance of the system to determine when major maintenance tasks are required.

Maintenance is the responsibility of the property owner. This is true whether the property owner is an individual where the land is private property or where the land is public with the responsibility assigned to that municipality. Maintenance shall be performed as outlined in this Operational and Maintenance Plan. Those responsible for the work shall have a copy of this plan and a copy of the complete design plans to aid them in understanding the intent and requirements unique to this Stormwater Management Facility.

All maintenance personnel shall be aware of the purpose of each stormwater management BMP in removing contaminants and Total Suspended Solids (TSS) from the stormwater runoff. The result is the collection, removal and storage of the contaminants within the components. The contaminants could include trash, debris, oil, sediment and soluble or insoluble materials. In most situations, these can be handled, stored and disposed with minimal safety requirements, in that the health hazards are minimal with the concentrations involved. However, the personnel should be aware of the risk and/or the possibility of potential dangers.

The maintenance personnel shall be aware of the safety needs involved with entry into confined areas such as sediment and oil separators and shall abide by all applicable OSHA regulations. Personnel should be familiar with local emergency numbers and have access to first aid materials. Maintenance personnel shall be familiar with local, state and federal regulations and guidelines concerning the disposal of all materials generated from the facilities as a result of maintenance. All waste materials shall be handled, stored, transported and disposed in accordance with those regulations.

## **SECTION 4.2 – RESPONSIBLE PARTIES**

The construction contractor as well as the owner will be the responsible parties during construction of the Stormwater Management System.

The future owner of the property, will be the responsible party during the post-development maintenance period of the Stormwater Management System.

## **SECTION 4.3 CONSTRUCTION PERIOD MAINTENANCE PROCEDURES**

Maintenance requirements are the most demanding during the construction phase of a project when the ground is disturbed with partial runoff control in a condition that is most likely to produce silt-laden runoff. During this period, the contractor and owner shall meet the design and performance standards of a fully constructed, stabilized system. Proper treatment of stormwater is only possible with a proper construction sequence plan and rigorous maintenance procedures of the storm water components

The general construction sequence, as it applies to the storm water management components shall be as follows:

1. Install erosion and sediment controls measures prior to disturbing soil and any temporary structures.
2. Conduct all soil-disturbing operations during the dry periods and not during times of precipitation.
3. Direct the storm water runoff into temporary pollution prevention structures.
4. Begin site work.
5. Stabilize grading and landscaped areas as soon as possible.

The following structures shall be in place during the construction phase and shall be maintained as outlined below.

### ***Erosion Control Measures***

*Responsible Party: Site Contractor*

- Straw wattle shall be placed and maintained as shown on the plan set.
- Straw wattle shall be inspected weekly during construction and after each rainstorm.
- Straw wattle shall be replaced if they become silt laden and no longer meet performance standards
- All sediments should be handled properly and disposed in accordance with local, state and federal guidelines and regulations.

### ***Deep Sump Catch Basin***

*Responsible Party: Site Contractor*

- Filter fabric, silt sacks, or the like shall be placed on top of the catch basin frame but beneath the grate (or erosion control lines such as silt socks shall entirely surround the catch basin frame and grate) for the duration of the construction process and shall be cleaned as needed, and removed at the conclusion of the construction period.
- Any construction period debris shall be removed from the Sump at the conclusion of the construction period

### ***Sediment and Oil Separator***

*Responsible Party: Site Contractor*

- No construction period debris shall enter the sediment and oil separator directly
- Deep Sump Catch Basin construction period protection as described above is essential for any runoff prior to entering the Sediment and Oil Separator
- Any construction period debris shall be removed from the Sediment and Oil Separator at the conclusion of the construction period

### ***Sub-surface Infiltration System (Stormtech Chambers)***

*Responsible Party: Site Contractor*

- Deep Sump Catch Basin and Sediment and Oil Separator construction period protection as described above is essential for any runoff prior to entering the Sub-surface Infiltration System
- Stabilize the site prior to installing the subsurface structure.
- Do not allow runoff from any disturbed areas on the site to flow to the structure
- Rope off the area where the subsurface structures are to be placed. Accomplish any required excavation with equipment placed just outside this area.

## **SECTION 4.4 POST-DEVELOPMENT MAINTENANCE PROCEDURES**

### ***Erosion Control Measures***

*Responsible Party: Property Owner*

- Straw wattle shall be removed following construction; contact the Conservation Commission to inspect stabilized area to conform to compliance requirements.

### ***Deep Sump Catch Basin***

*Responsible Party: Property Owner*

- Inspect the Deep Sump Catch Basin four times per year at minimum, or after significant storm events
- Clean the Deep Sump Catch Basin four times per year or whenever the depth of deposits is greater than or equal to one half the depth from the bottom of the invert of the lowest pipe in the Basin
- 

### ***Sediment and Oil Separator***

*Responsible Party: Property Owner*

- Inspect the Sediment and Oil Separator after every major storm but at least once per month
- Clean the Sediment and Oil Separator twice per year at minimum

### ***Sub-surface Infiltration System (Stormtech Chambers)***

*Responsible Party: Property Owner*

- Because subsurface structures are installed underground, they are extremely difficult to maintain
- Inspect inlets at least twice a year
- Remove any debris that may clog the system
- Refer to the manufacturer's specifications for maintenance of the Sub-surface Infiltration System as well as the Isolator Rows

Inspections of hoods, elbows, baffles, etc. at the catch basins and sediment & oil separators shall be conducted twice a year. Inspection and maintenance of lawns and landscaping (including trash/debris removal, etc.), and paved surfaces and sweeping shall be conducted twice a year.



**SECTION 5: ATTACHMENTS**



**StormTech**<sup>®</sup>

Detention • Retention • Water Quality

A division of **ADS**

SC-310/SC-740/DC-780



# StormTech Construction Guide

## REQUIRED MATERIALS AND EQUIPMENT LIST

- Acceptable fill materials per **Table 1**
- Woven and non-woven geotextiles
- StormTech solid end caps and pre-cored end caps
- StormTech chambers
- StormTech manifolds and fittings

### IMPORTANT NOTES:

**A.** This installation guide provides the minimum requirements for proper installation of chambers. Non-adherence to this guide may result in damage to chambers during installation. Replacement of damaged chambers during or after backfilling is costly and very time consuming. It is recommended that all installers are familiar with this guide, and that the contractor inspects the chambers for distortion, damage and joint integrity as work progresses.

**B.** Use of a dozer to push embedment stone between the rows of chambers may cause damage to chambers and is not an acceptable backfill method. Any chambers damaged by using the “dump and push” method are not covered under the StormTech standard warranty.

**C.** Care should be taken in the handling of chambers and end caps. Avoid dropping, prying or excessive force on chambers during removal from pallet and initial placement.

## Requirements for System Installation

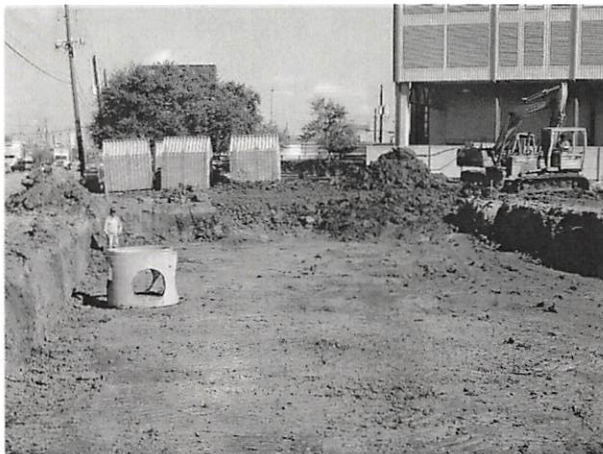

Excavate bed and prepare subgrade per engineer's plans.



Place non-woven geotextile over prepared soils and up excavation walls.



Place clean, crushed, angular stone foundation 6" (150 mm) min. Install underdrains if required. Compact to achieve a flat surface.

## Manifold, Scour Fabric and Chamber Assembly



Install manifolds and lay out woven scour geotextile at inlet rows [min. 12.5 ft (3.8 m)] at each inlet end cap. Place a continuous piece (no seams, double layer) along entire length of Isolator® Row(s).

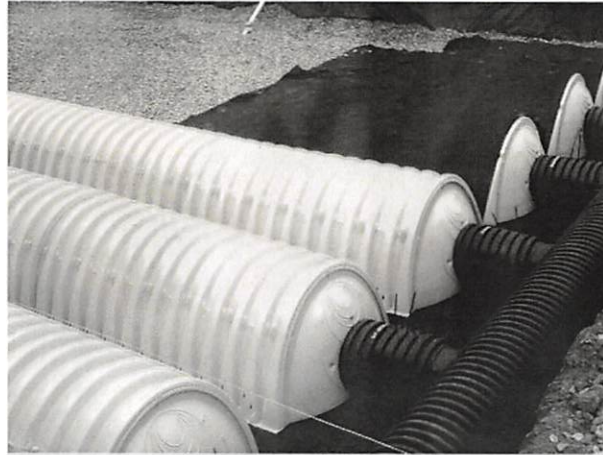

Align the first chamber and end cap of each row with inlet pipes. Contractor may choose to postpone stone placement around end chambers and leave ends of rows open for easy inspection of chambers during the backfill process.

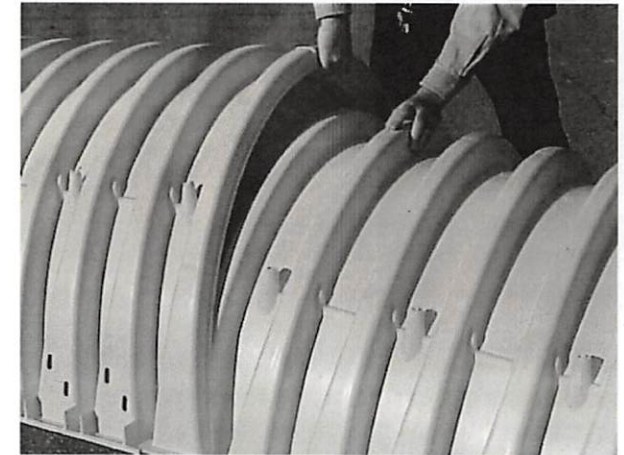

Construct the chamber bed by overlapping the chambers lengthwise in rows. Attach chambers by overlapping the end corrugation of one chamber on to the end corrugation of the last chamber in the row. Be sure that the chamber placement does not exceed the reach of the construction equipment used to place the stone.

## Attaching the End Caps

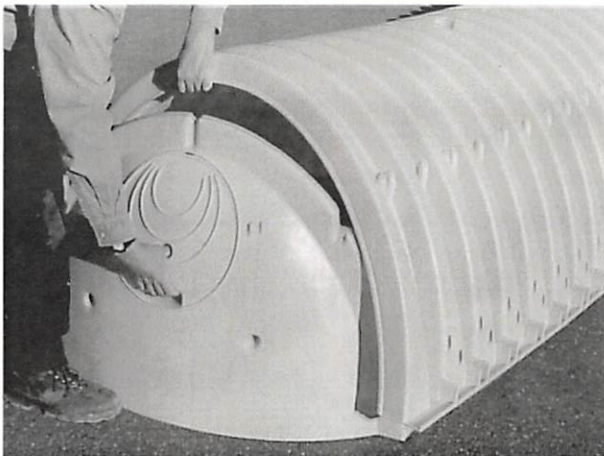

Lift the end of the chamber a few inches off the ground. With the curved face of the end cap facing outward, place the end cap into the chamber's end corrugation.

## Prefabricated End Caps

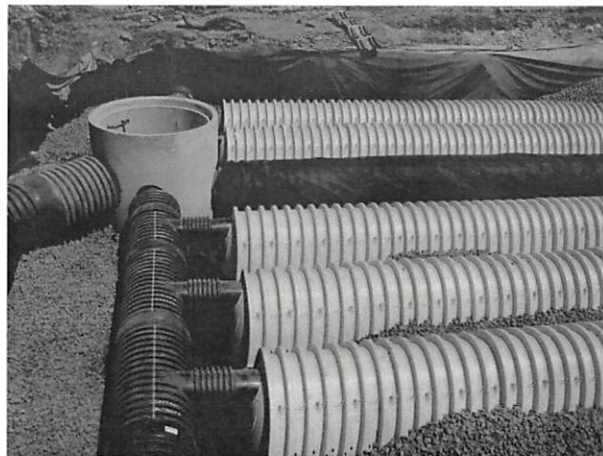

24" (600 mm) inlets are the maximum size that can fit into a SC-740/DC-780 end cap and must be prefabricated with a 24" (600 mm) pipe stub. SC-310 chambers with a 12" (300 mm) inlet pipe must use a prefabricated end cap with a 12" (300 mm) pipe stub.

## Isolator Row

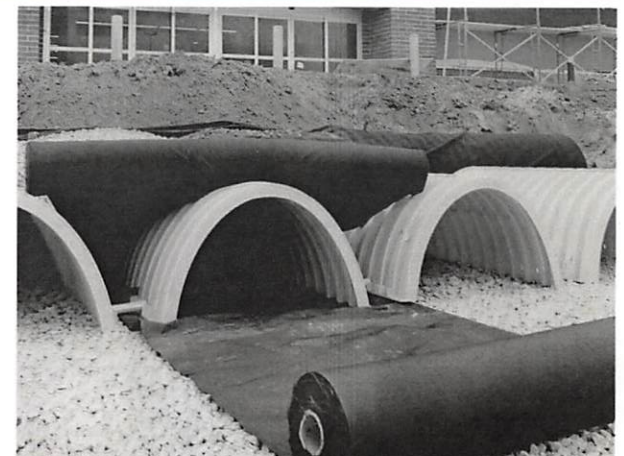

Drape a strip of ADS non-woven geotextile over the row of chambers (not required over DC-780). This is the same type of non-woven geotextile used as a separation layer around the angular stone of the StormTech system.

## Initial Anchoring of Chambers – Embedment Stone

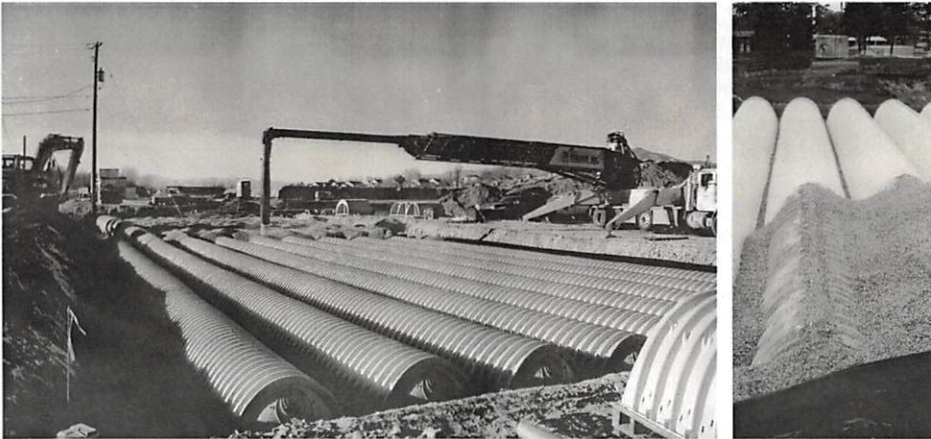

Initial embedment shall be spotted along the centerline of the chamber evenly anchoring the lower portion of the chamber. This is best accomplished with a stone conveyor or excavator reaching along the row.



No equipment shall be operated on the bed at this stage of the installation. Excavators must be located off the bed. Dump trucks shall not dump stone directly on to the bed. Dozers or loaders are not allowed on the bed at this time.

## Backfill of Chambers – Embedment Stone

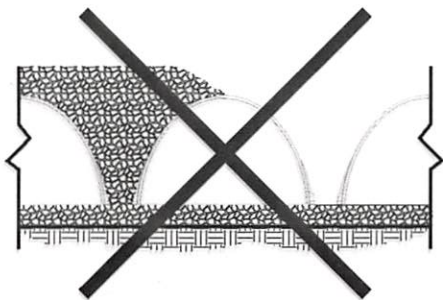

UNEVEN BACKFILL

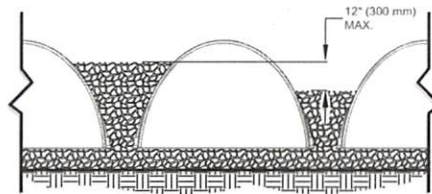

EVEN BACKFILL

Backfill chambers evenly. Stone column height should never differ by more than 12" (300 mm) between adjacent chamber rows or between chamber rows and perimeter.

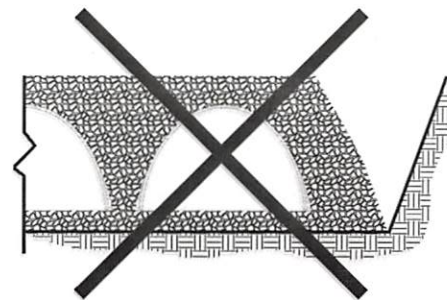

PERIMETER NOT BACKFILLED

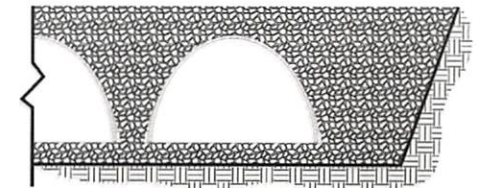

PERIMETER FULLY BACKFILLED

Perimeter stone must be brought up evenly with chamber rows. Perimeter must be fully backfilled, with stone extended horizontally to the excavation wall.

## Backfill of Chambers – Embedment Stone and Cover Stone

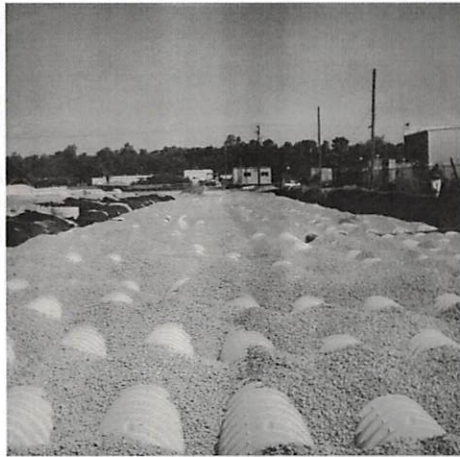

Continue evenly backfilling between rows and around perimeter until embedment stone reaches tops of chambers. Perimeter stone must extend horizontally to the excavation wall for both straight or sloped sidewalls. **Only after chambers have been backfilled to top of chamber and with a minimum 6" (150 mm) of cover stone on top of chambers can small dozers be used over the chambers for backfilling remaining cover stone.**

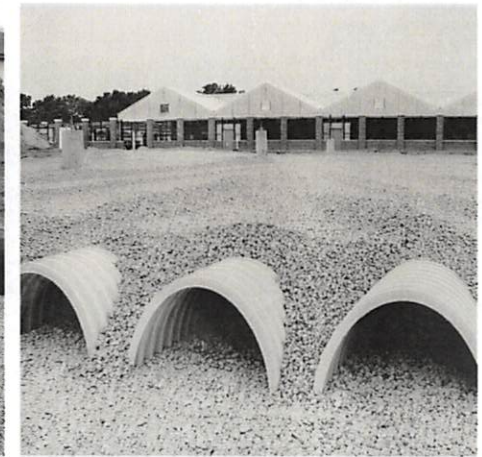

Small dozers and skid loaders may be used to finish grading stone backfill in accordance with ground pressure limits in Table 2. They must push material parallel to rows only. Never push perpendicular to rows. StormTech recommends that the contractor inspect chambers before placing final backfill. Any chambers damaged by construction shall be removed & replaced.

## Final Backfill of Chambers – Fill Material

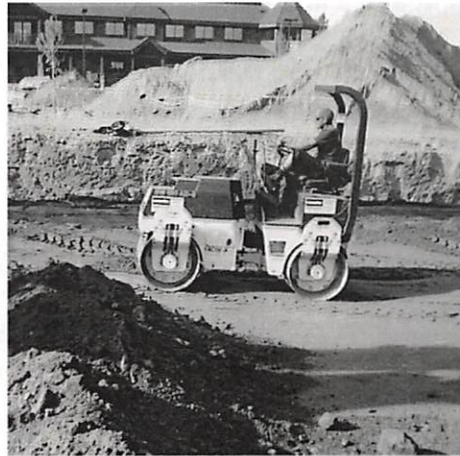

Install non-woven geotextile over stone. Geotextile must overlap 24" (600 mm) min. where edges meet. Compact each lift of backfill as specified in the site design engineer's drawings. Roller travel parallel with rows.

## StormTech Isolator Row Detail

COVER ENTIRE ISOLATOR ROW WITH ADS  
GEOSYNTHETICS 601T NON-WOVEN GEOTEXTILE  
SC-740 - 8' (2.4 m) MIN WIDE STRIP  
SC-310 - 5' (1.5 m) MIN WIDE STRIP

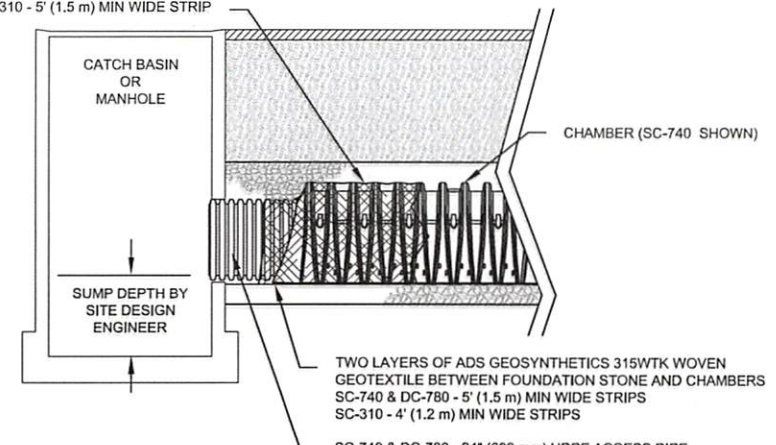

NOTE: NON-WOVEN GEOTEXTILE OVER DC-780  
ISOLATOR ROW CHAMBERS IS NOT REQUIRED.

SC-740 & DC-780 - 24" (600 mm) HDPE ACCESS PIPE  
SC-310 - 12" (300 mm) HDPE ACCESS PIPE  
USE FACTORY PRE-FABRICATED END CAP

**Table 1 – Acceptable Fill Materials**

Material Location	Description	AASHTO M43 Designation <sup>1</sup>	Compaction/Density Requirement
<b>D Final Fill:</b> Fill Material for layer 'D' starts from the top of the 'C' layer to the bottom of flexible pavement or unpaved finished grade above. Note that the pavement subbase may be part of the 'D' layer.	Any soil/rock materials, native soils or per engineer's plans. Check plans for pavement subgrade requirements.	N/A	Prepare per site design engineer's plans. Paved installations may have stringent material and preparation requirements.
<b>C Initial Fill:</b> Fill Material for layer 'C' starts from the top of the embedment stone ('B' layer) to 18" (450 mm) above the top of the chamber. Note that pavement subbase may be part of the 'C' layer.	Granular well-graded soil/aggregate mixtures, <35% fines or processed aggregate. Most pavement subbase materials can be used in lieu of this layer.	AASHTO M45 A-1, A-2-4, A-3 or AASHTO M43 <sup>1</sup> 3, 357, 4, 467, 5, 56, 57, 6, 67, 68, 7, 78, 8, 89, 9, 10	Begin compaction after min. 12" (300 mm) of material over the chambers is reached. Compact additional layers in 6" (150 mm) max. lifts to a min. 95% Proctor density for well-graded material and 95% relative density for processed aggregate materials. Roller gross vehicle weight not to exceed 12,000 lbs (53 kN). Dynamic force not to exceed 20,000 lbs (89 kN)
<b>B Embedment Stone:</b> Embedment Stone surrounding chambers from the foundation stone to the 'C' layer above.	Clean, crushed, angular stone nominal size distribution 3/4 - 2" (20 mm - 50 mm)	AASHTO M43 <sup>1</sup> 3, 357, 4, 467, 5, 56, 57	No compaction required.
<b>A Foundation Stone:</b> Foundation Stone below the chambers from the sub-grade up to the foot (bottom) of the chamber.	Clean, crushed, angular stone, nominal size distribution 3/4 - 2" (20 mm - 50 mm)	AASHTO M43 <sup>1</sup> 3, 357, 4, 467, 5, 56, 57	Place and compact in 6" (150 mm) lifts using two full coverages with a vibratory compactor. <sup>2,3</sup>

**PLEASE NOTE:**

- The listed AASHTO designations are for gradations only. The stone must also be clean, crushed, angular. For example, a specification for #4 stone would state: "clean, crushed, angular no. 4 (AASHTO M43) stone".
- StormTech compaction requirements are met for 'A' location materials when placed and compacted in 6" (150 mm) (max) lifts using two full coverages with a vibratory compactor.
- Where infiltration surfaces may be comprised by compaction, for standard installations and standard design load conditions, a flat surface may be achieved by raking or dragging without compaction equipment. For special load designs, contact StormTech for compaction requirements.

**Figure 1 – Inspection Port Detail**

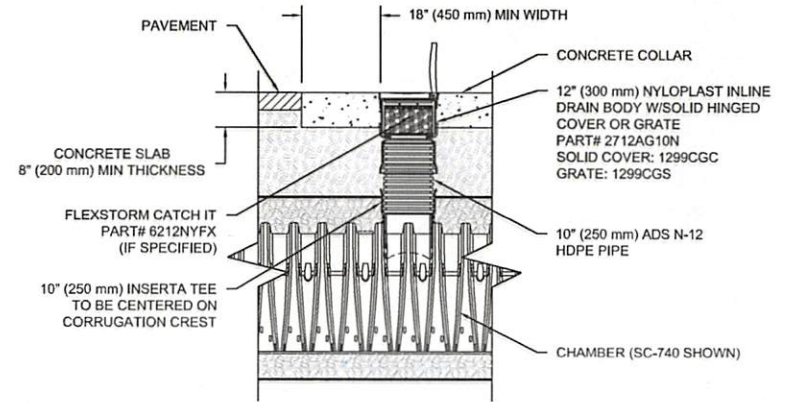

**Figure 2 – Fill Material Locations**

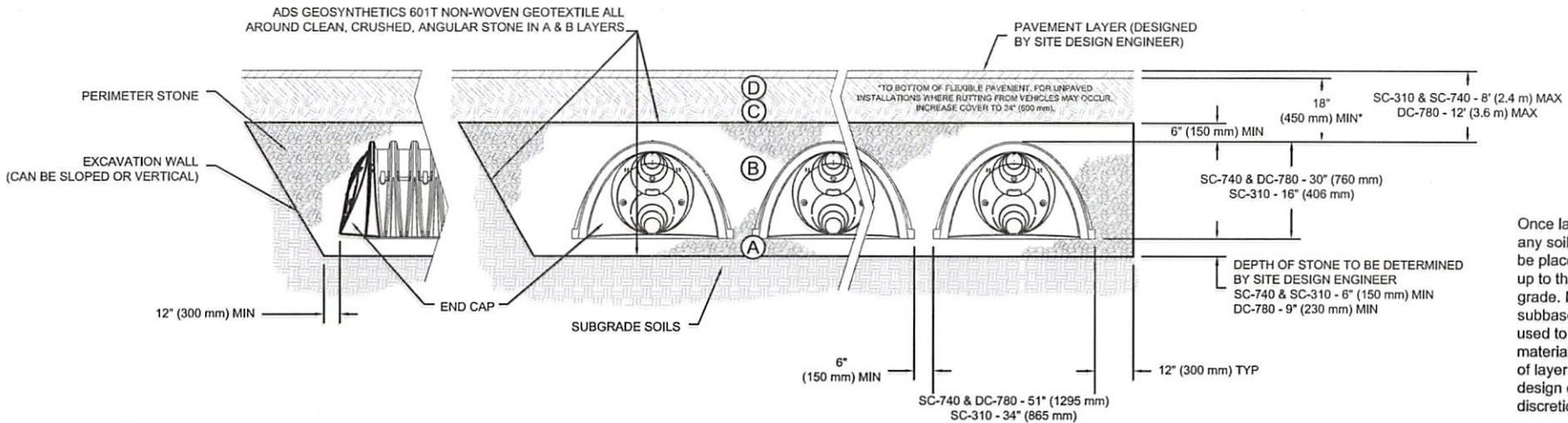

**NOTES:**

1. 36" (900 mm) of stabilized cover materials over the chambers is required for full dump truck travel and dumping.
2. During paving operations, dump truck axle loads on 18" (450 mm) of cover may be necessary. Precautions should be taken to avoid rutting of the road base layer, to ensure that compaction requirements have been met, and that a minimum of 18" (450 mm) of cover exists over the chambers. Contact StormTech for additional guidance on allowable axle loads during paving.
3. Ground pressure for track dozers is the vehicle operating weight divided by total ground contact area for both tracks. Excavators will exert higher ground pressures based on loaded bucket weight and boom extension.
4. Mini-excavators (< 8,000lbs/3,628 kg) can be used with at least 12" (300 mm) of stone over the chambers and are limited by the maximum ground pressures in Table 2 based on a full bucket at maximum boom extension.
5. Storage of materials such as construction materials, equipment, spoils, etc. should not be located over the StormTech system. The use of equipment over the StormTech system not covered in Table 2 (ex. soil mixing equipment, cranes, etc) is limited. Please contact StormTech for more information.
6. Allowable track loads based on vehicle travel only. Excavators shall not operate on chamber beds until the total backfill reaches 3 feet (900 mm) over the entire bed.

**Table 2 – Maximum Allowable Construction Vehicle Loads<sup>5</sup>**

Material Location	Fill Depth over Chambers in. [mm]	Maximum Allowable Wheel Loads		Maximum Allowable Track Loads <sup>6</sup>		Maximum Allowable Roller Loads
		Max Axle Load for Trucks lbs [kN]	Max Wheel Load for Loaders lbs [kN]	Track Width in. [mm]	Max Ground Pressure psf [kPa]	Max Drum Weight or Dynamic Force lbs [kN]
D Final Fill Material	36" [900] Compacted	32,000 [142]	16,000 [71]	12" [305]	3420 [164]	38,000 [169]
				18" [457]	2350 [113]	
				24" [610]	1850 [89]	
				30" [762]	1510 [72]	
				36" [914]	1310 [63]	
C Initial Fill Material	24" [600] Compacted	32,000 [142]	16,000 [71]	12" [305]	2480 [119]	20,000 [89]
				18" [457]	1770 [85]	
				24" [610]	1430 [68]	
				30" [762]	1210 [58]	
				36" [914]	1070 [51]	
	24" [600] Loose/Dumped	32,000 [142]	16,000 [71]	12" [305]	2245 [107]	Roller gross vehicle weight not to exceed 12,000 lbs. [53 kN]
				18" [457]	1625 [78]	
				24" [610]	1325 [63]	
	18" [450]	32,000 [142]	16,000 [71]	12" [305]	2010 [96]	Roller gross vehicle weight not to exceed 12,000 lbs. [53 kN]
				18" [457]	1480 [71]	
				24" [610]	1220 [58]	
				30" [762]	1060 [51]	
B Embedment Stone	12" [300]	16,000 [71]	NOT ALLOWED	12" [305]	1540 [74]	Roller gross vehicle weight not to exceed 12,000 lbs. [53 kN]
				18" [457]	1190 [57]	
				24" [610]	1010 [48]	
				30" [762]	910 [43]	
				36" [914]	840 [40]	
	6" [150]	8,000 [35]	NOT ALLOWED	12" [305]	1070 [51]	NOT ALLOWED
				18" [457]	900 [43]	
				24" [610]	800 [38]	
				30" [762]	760 [36]	
				36" [914]	720 [34]	

**Table 3 – Placement Methods and Descriptions**

Material Location	Placement Methods/ Restrictions	Wheel Load Restrictions	Track Load Restrictions	Roller Load Restrictions
		See Table 2 for Maximum Construction Loads		
D Final Fill Material	A variety of placement methods may be used. All construction loads must not exceed the maximum limits in Table 2.	36" (900 mm) minimum cover required for dump trucks to dump over chambers.	Dozers to push parallel to rows until 36" (900mm) compacted cover is reached. <sup>4</sup>	Roller travel parallel to rows only until 36" (900 mm) compacted cover is reached.
C Initial Fill Material	Excavator positioned off bed recommended. Small excavator allowed over chambers. Small dozer allowed.	Asphalt can be dumped into paver when compacted pavement subbase reaches 18" (450 mm) above top of chambers.	Small LGP track dozers & skid loaders allowed to grade cover stone with at least 6" (150 mm) stone under tracks at all times. Equipment must push parallel to rows at all times.	Use dynamic force of roller only after compacted fill depth reaches 12" (300 mm) over chambers. Roller travel parallel to chamber rows only.
B Embedment Stone	No equipment allowed on bare chambers. Use excavator or stone conveyor positioned off bed or on foundation stone to evenly fill around all chambers to at least the top of chambers.	No wheel loads allowed. Material must be placed outside the limits of the chamber bed.	No tracked equipment is allowed on chambers until a min. 6" (150 mm) cover stone is in place.	No rollers allowed.
A Foundation Stone	No StormTech restrictions. Contractor responsible for any conditions or requirements by others relative to subgrade bearing capacity, dewatering or protection of subgrade.			

ADS "Terms and Conditions of Sale" are available on the ADS website, [www.ads-pipe.com](http://www.ads-pipe.com).

Advanced Drainage Systems, the ADS logo, and the green stripe are registered trademarks of Advanced Drainage Systems. StormTech® and the Isolator® Row are registered trademarks of StormTech, Inc #090113 09/13

©2013 Advanced Drainage Systems, Inc.

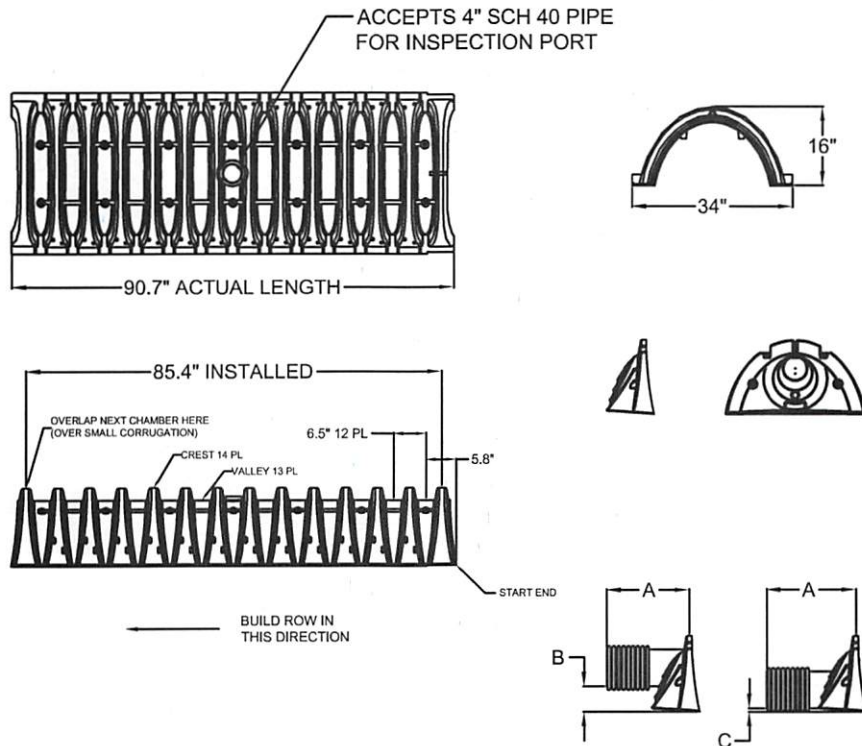

**NOMINAL CHAMBER SPECIFICATIONS**  
 SIZE (W x H x INSTALLED LENGTH)  
 CHAMBER STORAGE  
 MINIMUM INSTALLED STORAGE  
 WEIGHT

34.0" x 16.0" x 85.4"  
 14.7 CUBIC FEET  
 31.0 CUBIC FEET  
 35 LBS.

STUBS AT TOP OF END CAP  
 FOR PARTS NUMBERS  
 ENDING WITH "T"

STUBS AT BOTTOM OF END CAP  
 FOR PARTS NUMBERS  
 ENDING WITH "B"

PART #	CHAMBER	PIPE SIZE	A	B	C
SC310EPE06T	SC-310	6 in (150 mm)	9.50 in (244 mm)	5.80 in (147 mm)	N/A
SC310EPE06B	SC-310	6 in (150 mm)	9.50 in (244 mm)	N/A	0.50 in (13 mm)
SC310EPE08T	SC-310	8 in (200 mm)	11.90 in (302 mm)	3.50 in (89 mm)	N/A
SC310EPE08B	SC-310	8 in (200 mm)	11.90 in (302 mm)	N/A	0.60 in (15 mm)
SC310EPE10T	SC-310	10 in (250 mm)	12.70 in (323 mm)	1.40 in (36 mm)	N/A
SC310EPE10B	SC-310	10 in (250 mm)	12.70 in (323 mm)	N/A	0.70 in (18 mm)
* SC310EPE12B	SC-310	12 in (300 mm)	13.50 in (343 mm)	N/A	0.90 in (23 mm)

NOTE: ALL DIMENSIONS ARE NOMINAL

ALL STUBS, EXCEPT FOR THE SC310EPE12B ARE PLACED AT BOTTOM OF END CAP SUCH THAT THE OUTSIDE DIAMETER OF THE STUB IS FLUSH WITH THE BOTTOM OF THE END CAP. FOR ADDITIONAL INFORMATION CONTACT STORMTECH AT 1-888-892-2694.

\* FOR THE SC310EPE12B THE 12" STUB LIES BELOW THE BOTTOM OF THE END CAP APPROXIMATELY 0.25". BACKFILL MATERIAL SHOULD BE REMOVED FROM BELOW THE N-12 STUB SO THAT THE FITTING SETS LEVEL.

**STORMTECH LLC CONCEPTUAL PLAN DISCLAIMER**

THIS STORMTECH CHAMBER SYSTEM LAYOUT WAS PRODUCED TO DEMONSTRATE A BED LAYOUT THAT WILL HANDLE THE DESIGN VOLUME LISTED ABOVE. THE SIZING, FIT AND APPLICABILITY OF THE STORMTECH CHAMBER SYSTEM FOR THIS SPECIFIC PROJECT HAS NOT BEEN DETERMINED. IT IS THE ULTIMATE RESPONSIBILITY OF THE DESIGN ENGINEER TO ASSURE THAT THE STORMWATER SYSTEM DESIGN IS IN FULL COMPLIANCE WITH ALL APPLICABLE LAWS AND REGULATIONS. STORMTECH PRODUCTS MUST BE DESIGNED AND INSTALLED IN ACCORDANCE WITH STORMTECH'S MINIMUM REQUIREMENTS. STORMTECH LLC DOES NOT APPROVE PLANS, SIZING, OR SYSTEM DESIGNS. THE DESIGN ENGINEER IS RESPONSIBLE FOR ALL DESIGN DECISIONS.

\* NOTE: CHAMBER SYSTEM DESIGN MUST BE IN ACCORDANCE WITH STORMTECH DESIGN MANUAL

	20 Beaver Road, Suite 104 Wethersfield, CT 06109 Phone: 888-892-2694 Fax: 866-328-8401 www.stormtech.com	
	<b>SC-310 TECHNICAL SPECIFICATIONS</b>	
SCALE:	NTS	CHECKED
DATE:		ACAD No.
DRAWN BY:		SHEET OF



Colby Farm

**SOIL SUITABILITY FOR STORMWATER MANAGEMENT SYSTEM**

SITE: Colby Farm Newbury

DATE: 1/24/20

SOIL EVALUATOR/SOIL SCIENTIST: Steven Eriksen

Deep Observation Hole Number: 1

Depth (in.)	Soil Horizon/ Layer	Soil Matrix: Color-Moist (Munsell)	Redoximorphic Features (mottles)			Soil Texture (USDA)	Coarse Fragments % by Volume		Soil Structure	Soil Consistence (Moist)	Other
			Depth	Color	Percent		Gravel	Cobbles & Stones			
0-48	C1	10 yr 5/4				fsl	0	0	Loose	Single grain	

Additional Notes: no observed water, ledge at 48"

Soil Evaluator Exam 1/1/94 Soil Scientist Jan. 94 Signed:

**SOIL SUITABILITY FOR STORMWATER MANAGEMENT SYSTEM**

SITE: Colby Farm Newbury

DATE: 1/24/20

SOIL EVALUATOR/SOIL SCIENTIST: Steven Eriksen

Deep Observation Hole Number: 2

Depth (In.)	Soil Horizon/ Layer	Soil Matrix: Color-Moist (Munsell)	Redoximorphic Features (mottles)			Soil Texture (USDA)	Coarse Fragments % by Volume		Soil Structure	Soil Consistence (Moist)	Other
			Depth	Color	Percent		Gravel	Cobbles & Stones			
0-24	Ap	10 yr 2/2				fsl			loose	Massive	
24-72	C1	10 yr 5/4	24	5y 5/2	10	fsl	0	0	Loose	Single grain	

Additional Notes: observed water 24,

Soil Evaluator Exam 11/94 Soil Scientist Jan. 94 Signed:

**SOIL SUITABILITY FOR STORMWATER MANAGEMENT SYSTEM**

SITE: Colby Farm Newbury  
 DATE: 1/24/20 SOIL EVALUATOR/SOIL SCIENTIST: Steven Eriksen  
 Deep Observation Hole Number: 3

Depth (in.)	Soil Horizon/ Layer	Soil Matrix: Color-Moist (Munsell)	Depth	Redoximorphic Features (mottles)		Soil Texture (USDA)	Soil Structure		Other
				Color	Percent		Coarse Fragments % by Volume	Gravel	
0-18	Ap	10 yr 2/2			fsl		loose	Massive	
28-32	Bw	10 yr 5/4	24	5y 5/2	10				
32-108	C1	10 yr 5/4			fsl	0	0	Loose	Single grain

Additional Notes \_\_\_\_\_ observed water 24  
 Soil Evaluator Exam 11/94 Soil Scientist Jan. 94 Signed:

**SOIL SUITABILITY FOR STORMWATER MANAGEMENT SYSTEM**

SITE: Colby Farm Newbury

DATE: 1/24/20

SOIL EVALUATOR/SOIL SCIENTIST: Steven Eriksen

Deep Observation Hole Number: 4

Depth (in.)	Soil Horizon/ Layer	Soil Matrix: Color-Moist (Munsell)	Redoximorphic Features		Soil Texture (USDA)	Soil Structure			Soil Consistence (Moist)	Other	
			Depth	Color		Percent	Coarse Fragments % by Volume	Gravel			Cobbles & Stones
0-35	Ap, (buried)	10 yr 2/2			fsl				loose	Massive	
35-102	C1	10 yr 5/4	35	5y 5/2	10	fsl	0	0	Loose	Single grain	

Additional Notes \_\_\_\_\_ observed water 35 Soil Evaluator Exam 11/94 Soil Scientist Jan. 94 Signed:

**SOIL SUITABILITY FOR STORMWATER MANAGEMENT SYSTEM**

SITE: Colby Farm Newbury DATE: 1/24/20 SOIL EVALUATOR/SOIL SCIENTIST: Steven Eriksen  
 Deep Observation Hole Number: 5

Depth (In.)	Soil Horizon/ Layer	Soil Matrix: Color-Moist (Munsell)	Redoximorphic Features (mottles)			Soil Texture (USDA)	Coarse Fragments % by Volume		Soil Structure	Soil Consistence (Moist)	Other
			Depth	Color	Percent		Gravel	Cobbles & Stones			
0-18	Ap	10 yr 2/2				fsl			loose	Massive	
18-36	Bw	10 yr 5/4	36	5y 5/2	10	fsl	0	0	Loose	Single grain	
36-102	C1	10 yr 5/4				fsl	0	0	loose	Single grain	

Additional Notes \_\_\_\_\_ observed water 36,

Soil Evaluator Exam 1/1/94 Soil Scientist Jan. 94 Signed:

**SOIL SUITABILITY FOR STORMWATER MANAGEMENT SYSTEM**

SITE: Colby Farm Newbury

DATE: 1/24/20

SOIL EVALUATOR/SOIL SCIENTIST: Steven Eriksen

Deep Observation Hole Number: 6

Depth (in.)	Soil Horizon/ Layer	Soil Matrix: Color-Moist (Munsell)	Redoximorphic Features (mottles)			Soil Texture (USDA)	Coarse Fragments % by Volume		Soil Structure	Soil Consistence (Moist)	Other
			Depth	Color	Percent		Gravel	Cobbles & Stones			
0-24	Ap	10 yr 2/2				fsl			loose	Massive	
24-36	Bw	10 yr 5/4	36	5y 5/2	10	fsl	0	0	Loose	Single grain	

Additional Notes: observed water 24, Soil Evaluator Exam 11/94 Soil Scientist Jan. 94 Signed: