

## AVAILABLE VERSIONS

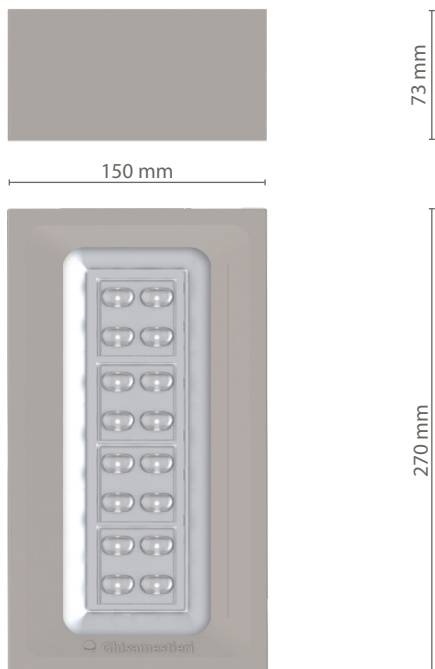

### Compact

No openable fixture: equipped with outgoing cable and fast connector IP68.



Scale: 1:5

**Max. weight** CXS

4,0 Kg

Lateral: 0,02 m<sup>2</sup> | Pian: 0,04 m<sup>2</sup>

## MODULE COMBINING

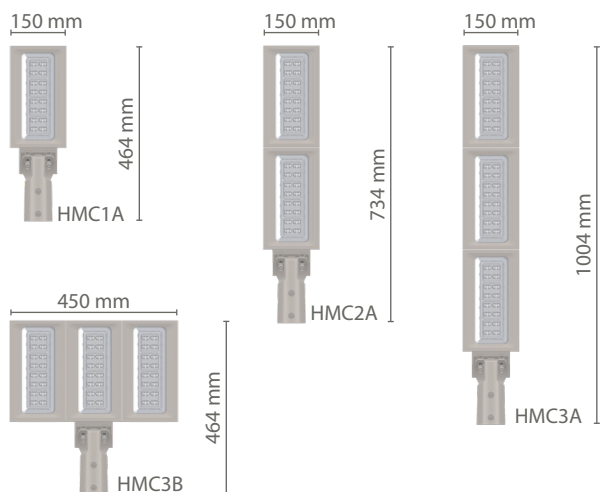

## FIXING TYPE



Side



Pole-top

Ø 42-60 mm  
Ø 60-76 mm

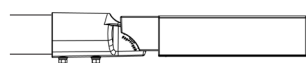

Adjustable with 5° step  
+5°  
0°  
-15°

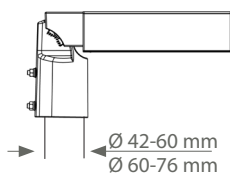

Adjustable with 5° step  
+15°  
0°

## STANDARD

EN 60598-1, EN 60598-2-3, EN 62471, EN 55015, EN 61547, EN 61000-3-2, EN 61000-3-3

## CONFORMITY | PROTECTION

### Conformity

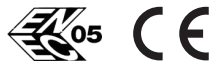

### Insulation classes



### Salt spray test

ISO 9227



8000 hr

### Protection classes



### Vibration test passed

IEC 60068-2-6



### Photobiological safety



Classe 0  
Exempt group  
IEC/TR62471

## PLUS



CUTOFF



OPTICAL FLEXIBILITY



LOW GLARE



IPEA MIN

## LIGHTING FIXTURE FEATURES

### General features

Power source:	220-240V   50/60Hz   tolerance +/-10%   other voltages on request
Current supply:	525mA   700 mA (P <sub>max</sub> [3 modules]= 105 W)
Power Factor   THD:	≥0.95   <10 % (At full load)
Expected life (Ta=25°):	> 100.000 h   L90B10   @700mA
Operational temperature (Ta):	T <sub>min</sub> = -40°C T <sub>max</sub> = +55°C   700 mA
Storage temperature:	-40°C/+80°C
Overcharge protection:	Impulse whitstand up to 10kV CM/DM
Standard functions:	Current fixed   Virtual midnight   1-10V   CLO (Details pag.4)

### Materials

Lighting fixture:	Die cast aluminium   EN1706 Extruded aluminium   EN573-3
Optical system:	Nano-optics in PMMA Plastic reflector metallic painted
Screen:	Ultraclear tempered glass   Th. 4mm
Gaskets:	Silicon
Cable gland:	Polyamide PA66   PG16   Ø 14mm MAX   IP 68
Screws and bolts:	AISI 304 stainless steel
Fixture color:	Light grey Ghisamestieri®

## LED FEATURES

LED data 4.000 K - 700mA:	340 lm/LED   180 lm/W   25°C [Tj]   ≤ 3 step macadam
Colour temperature:	3.000 K   4.000 K   5.700 K   CRI ≥ 70
"Flip chip LED" technology:	Hight performance and hight quality LED equipped with gold electrode; hight protection against corrosion and color shifting.

## OPTIONAL

Overcharge protection:	optional - SPD with warning LED CLASS 1   CLASS 2 10kV / 10kA CM/DM
Optional functions:	DALI-DALI2 (Details pag.4)



### PEDESTRIAN PATHS\\ OPTIC TYPES 2

#### TYPE 2A

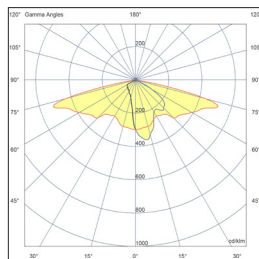

**Asymmetrical light**, designed to suit streets and pedestrian or cycle paths.



### URBAN AND SUBURBAN STREETS, SQUARES, PARKING LOTS AND ROUNDABOUTS\\ OPTIC TYPES 3

#### TYPE 3A

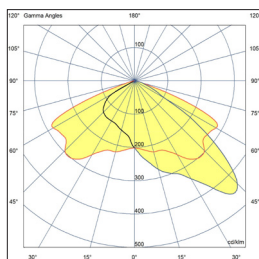

**Asymmetrical light**, designed to suit streets and road wet surface.

#### TYPE 3B

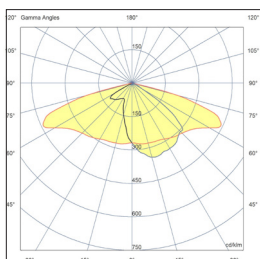

**Asymmetrical light**, designed to suit suburban and urban streets.

#### TYPE 3C

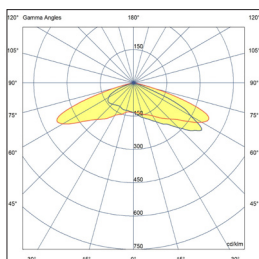

**Asymmetrical light**, designed to suit very large streets, parking lots and roundabouts.

#### TYPE 3D

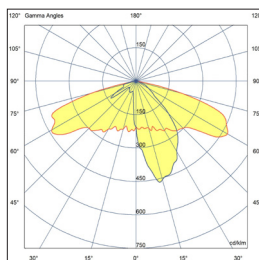

**Asymmetrical light**, designed to suit streets and pedestrian paths.

#### TYPE 3E

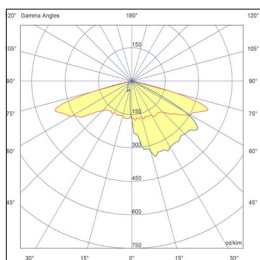

**Asymmetrical light**, designed to suit very large streets, parking lots and roundabouts.

#### TYPE 3F

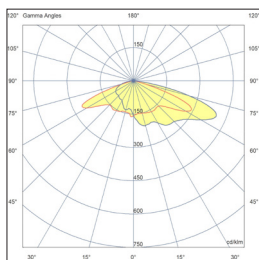

**Asymmetrical light**, designed to suit very large streets and road with a low installation of the lighting fixture, parking lots and roundabouts.



### PEDESTRIAN CROSSINGS\\ OPTIC TYPES 4

#### TYPE 4A

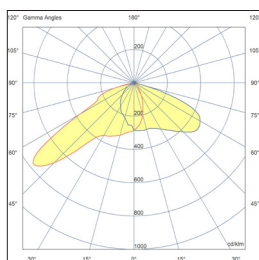

**Asymmetrical light**, designed to suite installation to pedestrian crossings.

#### TYPE 4B

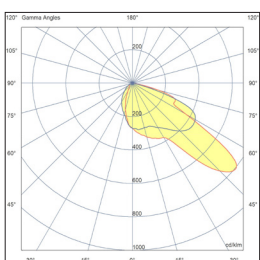

**Asymmetrical light**, designed to suite installation to pedestrian crossings.



### PARKS AND SQUARES\\ OPTIC TYPES 5

#### TYPE 5A

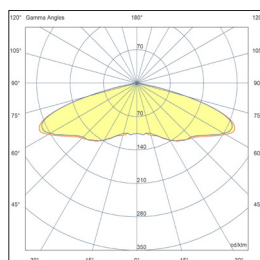

**Symmetrical light**, designed to be installed in parks, squares, parking lots and other large surfaces.

### APPLICATION EXAMPLES\\

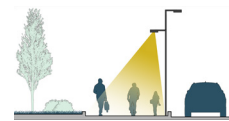

TYPE 2A | TYPE 3D



TYPE 2A | TYPE 3D



TYPE 3A | TYPE 3B

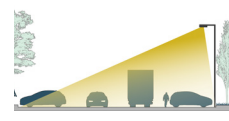

TYPE 3C | TYPE 3E | TYPE 3F

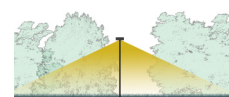

TYPE 5A

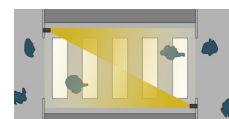

TYPE 4A | TYPE 4B



TYPE 4A + TYPE 4B



The LED modules nominal data refers only to the LED light sources in a standard version, with 4000 K color temperature, color rendering index CRI 70 min. and a junction temperature  $t_j$  of 25°C. The LED nominal data are extrapolated from the manufacturer documentations.

The lighting fixture measured data refers to GHISAMESTIERI products in a standard version, with 4000 K color temperature, optica type <<Ottica>> and an ambient temperature  $t_a$  of 25 °C.

Ghisamestieri offers the possibility of driving the device with custom currents (\*).

To obtain luminous fluxes and efficiencies of the lighting fixture in case of optic type and/or color temperature and/or color rendering index different from the standard use the conversion factors shown in the tables.

### LED modules nominal data (4000 K | CRI 70 min. | $t_j=25^\circ$ )

LED code	I [mA]	Luminous flux [lm]	Power [W]	Efficiency [lm/W]
GL04 	525	4255	23,0	185
	700	5394	31,0	174
GL08 	525	8510	46,0	185
	700	10788	62,0	174
GL12 	525	12765	69,0	185
	700	16008	92,0	174

### Lighting fixture measured data (4000 K | OTTICA 3B | $t_a=25^\circ$ )

Order code:	(*) I [mA]	Luminous flux [lm]	Power [W]	Efficiency [lm/W]
HMC1A_GL04 	525	3652	27,0	135
	700 (max)	4723	36,0	131
HMC2A_GL08 	525	7354	52,5	140
	700 (max)	9511	70,0	136
HMC3A_GL12    HMC3B_GL12 	525	11031	77,0	143
	700 (max)	14267	103,0	139

#### OPTIC CONVERSION FACTOR LUMINOUS FLUX

Optic type	Flux multiplier
1A (*)	1,00
2A (*)	0,99
3A   3C   3D   3E   3F	0,99
4A   4B	0,98
5A (*)	1,01

#### Tk CONVERSION FACTOR LUMINOUS FLUX

Tk [K]	Flux multiplier
2.200 (**)	0,70
3.000	0,94
5.700	1,01

#### CRI CONVERSION FACTOR LUMINOUS FLUX

CRI (color render index)	Flux multiplier
70	1,00
80	0,93

(\*) See pag.2 to check the optic type availability.

(\*\*) See pag.1 to check the colour temperature availability.

## Functions

### Standard functions

#### Fixed Output

The lighting fixture is set to use a fixed current among the standard ones indicated in the tables on page 3. It is possible to set other currents on customer request (custom).

#### Virtual midnight | Automatic lighting control

The driver is programmed to automatically switch the light On or Off based on the time of the day ensuring high energy saving.

The maximum output is usually set during the first and last hours of operation that statistically are proven to have higher traffic, it will then decrease during the middle hours when there is less traffic. The system is able to automatically regulate itself, identifying the average between the instant it turns on and turns off. This is called "virtual midnight" and is the reference point for reducing the light emission based on the desired profile. The output will automatically adapt to the length of the night throughout the year.

#### 1-10V | Flux control by analogic control

It is possible to adjust the amount of luminous output by means of an analog input signal that has a minimum level of 1V and maximum of 10V. The device is fitted with L-N-1 / 10V cable connection.

#### CLO | Costant lumen output

Considering LED performance deteriorates with use and time, it may be compensated by using a lower than maximum flux output and maintaining it constant in time by progressively increasing the current. In this case maintenance and management costs of the systems are considerably lower.

### Optional functions

#### DALI - DALI2 | Controllo e programmazione digitale

On request, the lighting body can be supplied with a DALI interface. The DALI system allows a lighting system to be controlled by providing control and diagnostic functions.

#### DALI SENSOR

With the DALI SENSOR interface it is possible to manage the functions of the DALI - DALI2 protocol. In addition, there is a low voltage AUX switch to manage remote control systems and external sensors in a Smart City perspective.

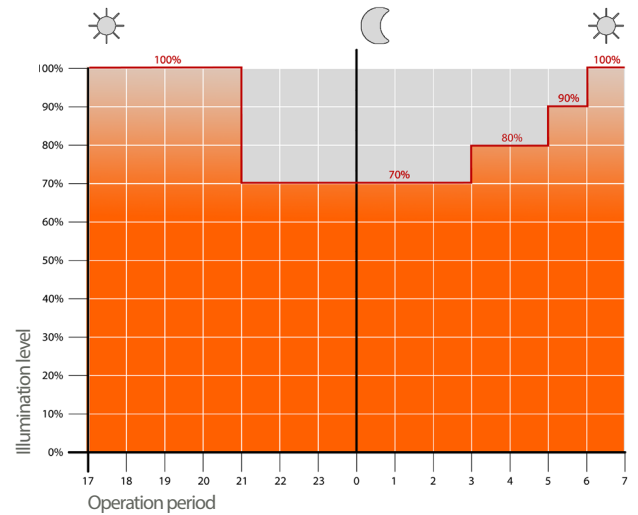

Example of 4-step adjustment with virtual midnight

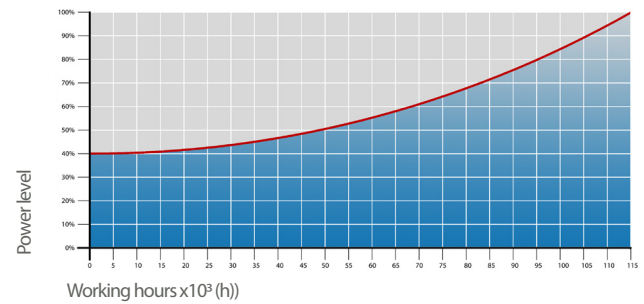

CLO | Costant lumen output

## Protection cycles

Ghisamestieri works with cast iron, steel and aluminum. The materials are selected and processed to maximize performance and quality.

### GALVANIZED STEEL

#### Protection of galvanized steel surfaces for poles

The protection of galvanized steel elements is achieved by following steps:

- Micro sandblasting;
- First epoxy layer application followed by:  
Wilting > Drying > Cooling;
- Acrylic glaze layer application followed by:  
Wilting > Drying > Cooling;
- Packing at least after 24-hour-drying at room temperature.

#### Protection of galvanized steel surfaces for brackets and pastorals

The protection of the galvanized steel elements is achieved thanks to:

- Micro sandblasting;
- Phosphoric pickling bath at a pH level ranging from 1.5 to 3;
- Rinsing with demineralised water;
- First powder layer application;
- Kiln firing;
- Application of a final powder layer;
- Kiln roasting of the final powder layer at 180°;
- Cooling.

### CAST IRON

#### Protection of cast iron surfaces for bases

The protection of cast iron elements is achieved by the following treatments:

- Surface micro shotblasting;
- Mono-component dip galvanizing followed by:  
Wilting > Drying > Cooling;
- Epoxy micaceous primer application followed by:  
Wilting > Drying > Cooling;
- Acrylic enamel application followed by:  
Wilting > Drying > Cooling;
- Packing at least after 24-hour-drying at room temperature.

### DIE-CAST ALUMINIUM

#### Protection of die-cast aluminium surfaces for lighting fixtures, tops, collars, brackets and pastorals

Brackets, pastoral, and die-cast accessories undergo a cycle of powder painting which creates a barrier against the corrosion of metal parts. Moreover this barrier makes the finished product comply with design specifications in terms of surface roughness, color and reflectance. The cycle consists of the following steps:

- Micro sandblasting;
- Hot pickling bath in a zinc-based phosphodegreasing solution;
- Specific process for the preparation of surfaces before painting;
- Washing with water;
- Rinsing with demineralised water and subsequent drying;
- First powder layer application followed by kiln baking at 180°;
- Final powder layer application using a High Durability product and final kiln roasting at 180°C.



Salt spray test | FLORIDA TEST

The top quality of such treatments is confirmed by salt spray tests performed in accordance with standard ISO 9227:2017 Neutral Salt Spray test (NSS).

The test was carried out for 8.000 hours at 35 °C and demonstrated through the report test released.



**Ghisamestieri the green way of light s.r.l.**

Legal headquarters:  
Strada Provinciale Specchia - Alessano, 68 • 73040 (LE)

Administrative and operational headquarters:  
Via Grande n°226 • 47032 Bertinoro (FC)

T +39 0543 462611  
F +39 0543 449111

**info@ghisamestieri.it**  
**www.ghisamestieri.it**

# Hulla Regolo pole 050

Product code: **HRP050**



Flange  
HRP050\_F



Foundation  
HRP050\_M

S235 cast iron pole hot galvanized and powder coated, prepared for lighting fixture Hulla installation. The pole is equipped with an M12 screw, steel inox AISI 304 (grounding). Pole-top bracket: for 1 to 3 Hulla modules

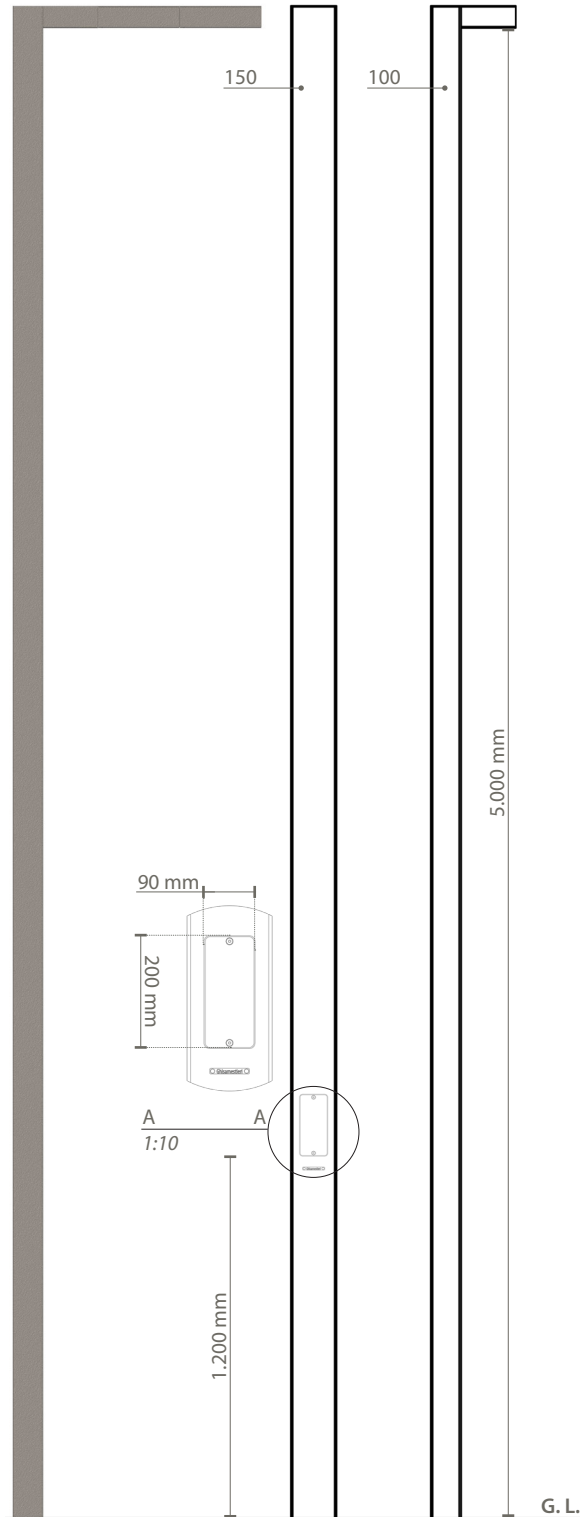

Scale: 1:25

## Conformity



## Geometry and mechanical features

Total height:	5.000 mm
Total weight:	⊕ flange: 72 kg
	⊕ foundation: 72 Kg

## Materials and color

Body:	Steel S235 - hot galvanized   EN 10027 - EN1461
Color:	Light grey Ghisamestieri®

## Terminal block M5 4x16mm<sup>2</sup>

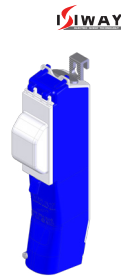

## Fixing type



Flange

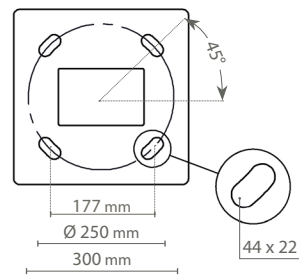

Foundation

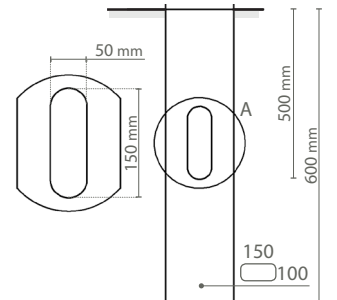

Supplied:  
Heat-shrink sheat

## Composition code

### Single pole

- ⊥ HRP050\_F\_01    ⊕ HRP050\_M\_01

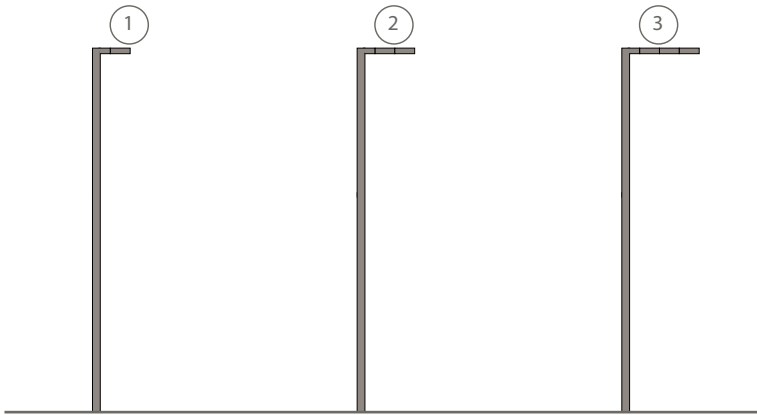

- ⊥ HRP050\_F\_01\_01    ⊥ HRP050\_F\_01\_02    ⊥ HRP050\_F\_01\_03  
 ⊕ HRP050\_M\_01\_01    ⊕ HRP050\_M\_01\_02    ⊕ HRP050\_M\_01\_03

### Double pole

- ⊥ HRP050\_F\_02    ⊕ HRP050\_M\_02

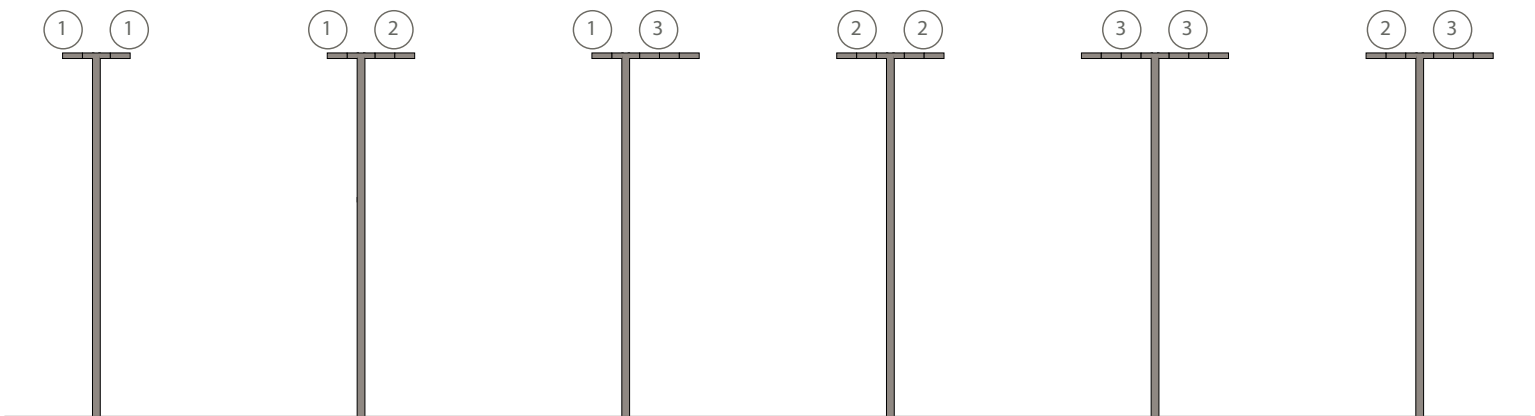

- ⊥ HRP050\_F\_02\_01\_01    ⊥ HRP050\_F\_02\_02\_01    ⊥ HRP050\_F\_02\_03\_01    ⊥ HRP050\_F\_02\_02\_02    ⊥ HRP050\_F\_02\_03\_03    ⊥ HRP050\_F\_02\_03\_02  
 ⊕ HRP050\_M\_02\_01\_01    ⊕ HRP050\_M\_02\_02\_01    ⊕ HRP050\_M\_02\_03\_01    ⊕ HRP050\_M\_02\_02\_02    ⊕ HRP050\_M\_02\_03\_03    ⊕ HRP050\_M\_02\_03\_02

### Split-level pole

- ⊥ HRP050\_F\_07    ⊕ HRP050\_M\_07

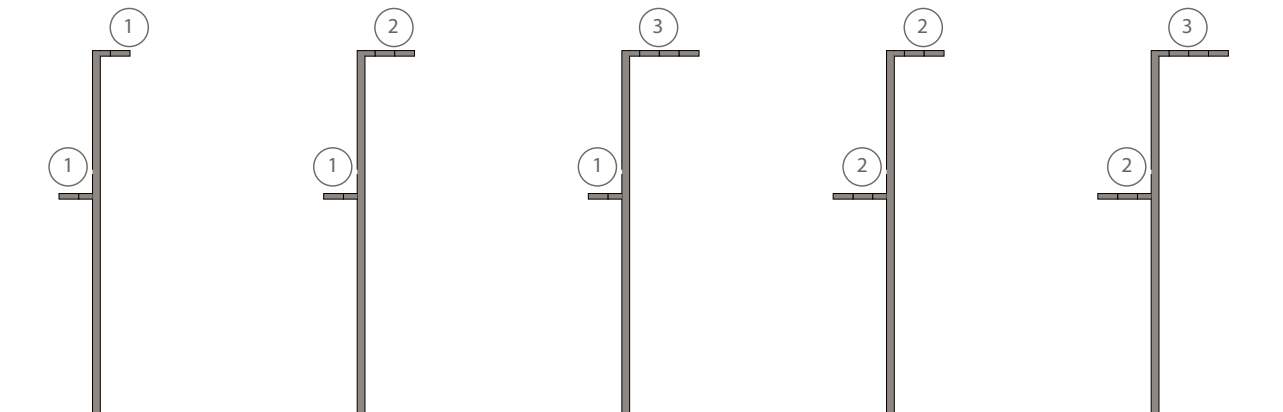

- ⊥ HRP050\_F\_07\_01\_01    ⊥ HRP050\_F\_07\_02\_01    ⊥ HRP050\_F\_07\_03\_01    ⊥ HRP050\_F\_07\_02\_02    ⊥ HRP050\_F\_07\_03\_02  
 ⊕ HRP050\_M\_07\_01\_01    ⊕ HRP050\_M\_07\_02\_01    ⊕ HRP050\_M\_07\_03\_01    ⊕ HRP050\_M\_07\_02\_02    ⊕ HRP050\_M\_07\_03\_02

## Protection cycles

### GALVANIZED STEEL

#### Protection of galvanized steel surfaces for poles

The protection of galvanized steel elements is achieved by following steps:

- Micro sandblasting
- First epoxy layer application followed by:  
Wilting > Drying > Cooling
- Acrylic glaze layer application followed by:  
Wilting > Drying > Cooling
- Packing at least after 24-hour-drying at room temperature.

#### Protection of galvanized steel surfaces for brackets and pastorals

The protection of the galvanized steel elements is achieved thanks to:

- Micro sandblasting
- Phosphoric pickling bath at a pH level ranging from 1.5 to 3
- Rinsing with demineralised water
- First powder layer application
- Kiln firing
- Application of a final powder layer
- Kiln roasting of the final powder layer at 180°
- Cooling.

### CAST IRON

#### Protection of cast iron surfaces for bases

The protection of cast iron elements is achieved by the following treatments:

- Surface micro shotblasting
- Mono-component dip galvanizing followed by:  
Wilting > Drying > Cooling
- Epoxy micaceous primer application followed by:  
Wilting > Drying > Cooling
- Acrylic enamel application followed by:  
Wilting > Drying > Cooling.
- Packing at least after 24-hour-drying at room temperature.

### DIE-CAST ALUMINIUM

#### Protection of die-cast aluminium surfaces for lighting fixtures, tops, collars, brackets and pastorals

Brackets, pastoral, and die-cast accessories undergo a cycle of powder painting which creates a barrier against the corrosion of metal parts. Moreover this barrier makes the finished product comply with design specifications in terms of surface roughness, color and reflectance. The cycle consists of the following steps:

- Micro sandblasting
- Hot pickling bath in a zinc-based phosphodegreasing solution
- Phospho-chromatation for surfeces clearing
- Washing with water
- Rinsing with demineralised water and subsequent drying
- First powder layer application followed by kiln baking at 180°
- Final powder layer application using a High Durability product and final kiln roasting at 180°C.



Salt spray test | FLORIDA TEST

The top quality of such treatments is confirmed by the succesfull results of specific salt spray test ( all products exceeded widely 2.500 hours) and the strictest international tests, among which FLORIDA TEST.

The salt spray test is made in accordance with standard UNI EN ISO 9227.



**Ghisamestieri the green way of light s.r.l**

Legal headquarters:  
Strada Provinciale Specchia - Alessano, 68 • 73040 (LE)

Administrative and operational headquarters:  
Via Grande n°226 • 47032 Bertinoro (FC)

T +39 0543 462611  
F +39 0543 449111

[info@ghisamestieri.it](mailto:info@ghisamestieri.it)  
[www.ghisamestieri.it](http://www.ghisamestieri.it)